

Description

The device provides simple and performance electronics ballast control function for the half bridge L/C resonant inverter. This device is optimized for electronics ballast requiring a minimum board area, reduced component count and low power dissipation. Internal soft start circuitry eliminates the need for an external soft start PTC resistor. The initial soft start frequency and soft start time can be easily adjusted depending on the types of lamp. Prevent burning out of switches in no lamp condition. Internal 18V regulator clamps Vcc line of supply voltage for eliminating an external zener diode.

Features

- No lamp protection
- Low Start up & Operating Current
- Internal Soft Start
- Flexible Soft Start Frequency
- Trimmed 1.5% internal Reference
- Under Voltage Lock Out with Hysteresis
- High Current Totem Pole Gate Drive

Ordering Information

Type NO.	Marking	Package Code
S6510	S6510	SOP-8

Outline Dimensions

unit : mm

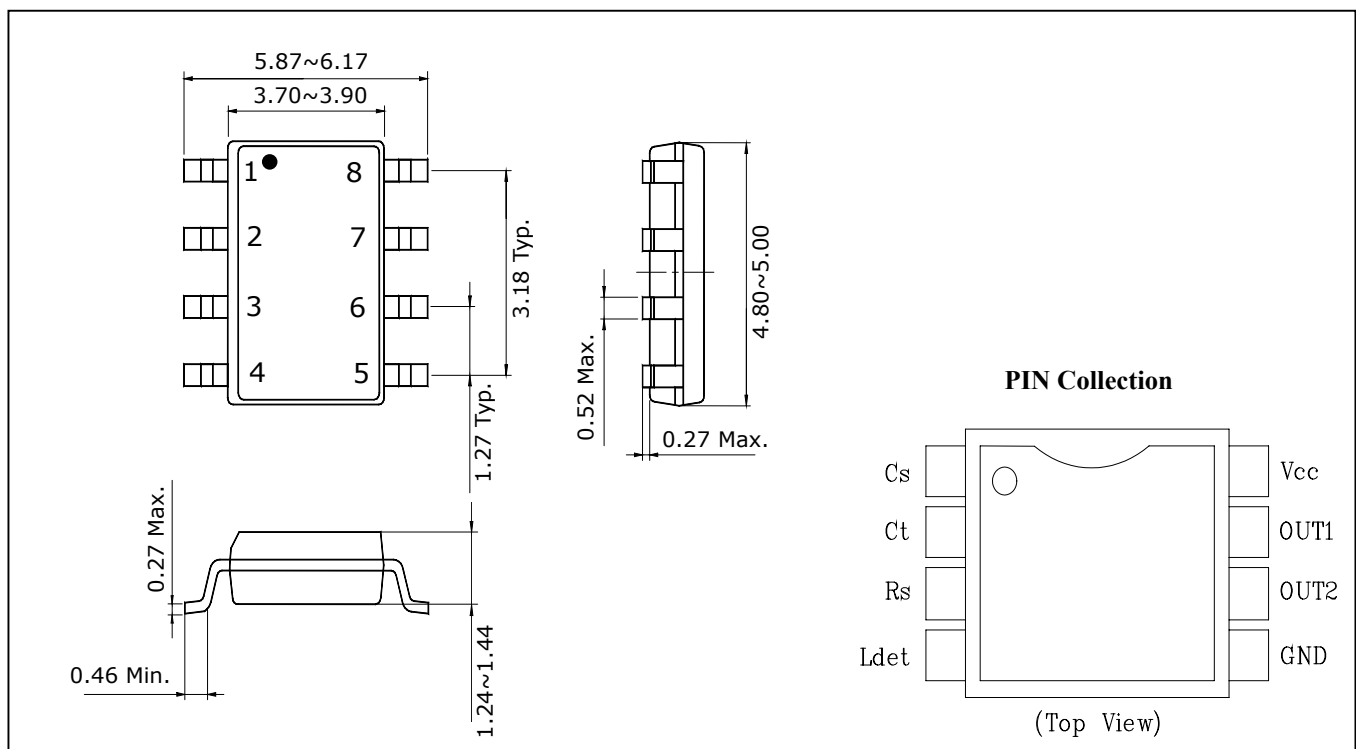

Internal Block Diagram

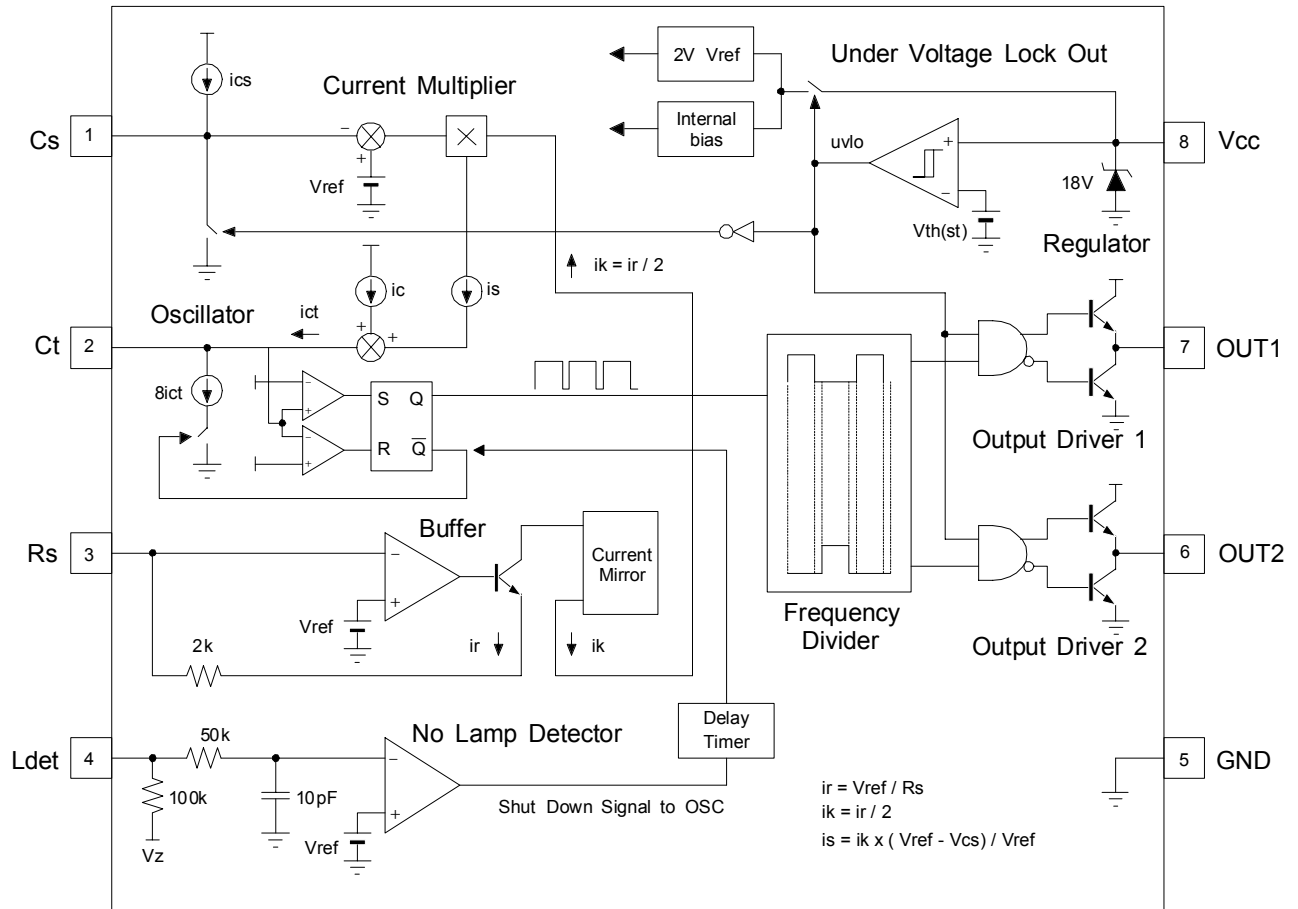

PIN Collection

Pin Number	Pin Name	Pin Function Description
1	Cs	Soft start time capacitor connection pin. The pin charge time to Vref determines The preheating time of lamp.
2	C _T	Timing capacitor connection pin. The timing capacitor is charged and discharged To generate the sawtooth waveform that determines the oscillator frequency in the internal oscillator.
3	Rs	Soft start resistor connection pin. The soft start resistor value determines the initial soft start frequency for preheating.
4	Ldet	Input to the protection circuit. If the pin voltage is lower than Vref, the output oh The output driver1,2 is inhibited.
5	GND	Ground of the control Section.
6	OUT2	Gate drive output. A push pull output stage is able to drive the Power MOSFET With peak current of 400mA.
7	OUT1	Gate drive output. A push pull output stage is able to drive the Power MOSFET With peak current of 400mA.
8	Vcc	Supply Voltage of output driver and control circuits.

ABSOLUTE MAXIMUM RATINGS

CHARACTERISTICS	SYMBOL	VALUE	UNITS
Supply Voltage	V _{cc}	19	V
Peak Drive Output Current	I _{oh} , I _{oI}	± 400	mA
Driver Output Clamping Diodes V _o >V _{cc} > or V _o <-0.3V	I _{clamp}	± 10	mA
Soft Start and No lamp detection Input Voltage	V _{in}	-0.3 to 6	V
Operating temperature range	T _{opr}	-25 to 125	°C
Storage temperature range	T _{stg}	-65 to 150	°C
Power Dissipation	P _d	0.5	W

Electrical Characteristics

V_{cc}=12V, 0°C ≤ T_a ≤ 105°C, unless otherwise stated.

Characteristic	Symbol	Test Condition	Min.	Typ.	Max.	Unit
SUPPLY VOLTAGE & CURRENT SECTION						
Start Threshold Voltage	V _{th(st)}	V _{cc} Increasing	9.5	10.5	11.5	V
UVLO Hysteresis	HT(st)	-	1.5	2.5	3.5	V
Start up Supply Current	I _{st}	V _{cc} =9V	20	50	80	μA
Operating Supply Current	I _{cc}	Output not switching	-	3	6	mA
Dynamic Operating Supply Current	I _{dcc}	50kHz, C _I =1nF	-	5	10	mA
Supply Voltage	V _{cc}	I _{cc} =30mA	17	18	19	V
ERROR AMPLIFIER SECTION						
Voltage Feedback Input Threshold	V _{ref}	I _{ref} =0mA, T _a =25°C	1.95	2	2.05	V
Line Regulation	ΔV _{ref1}	12V ≤ V _{cc} ≤ 17V	0	0.1	10	mV
Temperature Stability of V _{ref}	ΔV _{ref2}	Temp= 0°C to 75°C	-	15	-	mV
SOFT START SECTION						
Soft start Timing Current	I _{cs}	C _s =0V, C _t =0V	0.5	2.5	5	μA
R _s Buffer Voltage	V _{rs}	R _s =22K	1.9	2	2.1	V
OSCILLATOR SECTION						
Operating Frequency	f _{os}	V _{cs} =3V, C _t =470pF	43	46	49	kHz
Operating Dead Time	t _{od}	V _{cs} =3V, C _t =470pF	1	1.5	2	μs
Soft Start Frequency	f _{ss}	V _{cs} =0V, R _s =22K	65	70	75	kHz
Initial Soft Start Dead Time	t _{sd}	V _{cs} =0V, R _s =22K	0.5	1	1.5	μs

Electrical Characteristics

V_{cc}=12V, 0°C ≤ T_a ≤ 105°C, unless otherwise stated.

Characteristic	Symbol	Test Condition	Min.	Typ.	Max.	Unit
OUTPUT SECTION						
Output Voltage High	V _{oh}	I _o =-10mA	8.5	10	-	V
Output Voltage Low	V _{ol}	I _o = 10mA	-	0.5	2	V
Rising Time	t _r	C _I =1nF	-	200	-	ns
Falling Time	t _f	C _I =1nF	-	50	-	ns
Output Voltage with UVLO Activated	V _{o(uvlo)}	V _{cc} =5V, I _o =50 μA	-	-	1	V
PROTECTION SECTION						
No Lamp Detect Voltage	V _{nd}	-	1.9	2	2.1	V

Electrical Characteristic Curves

Fig. 1 Start up Supply Current vs. Supply Voltage

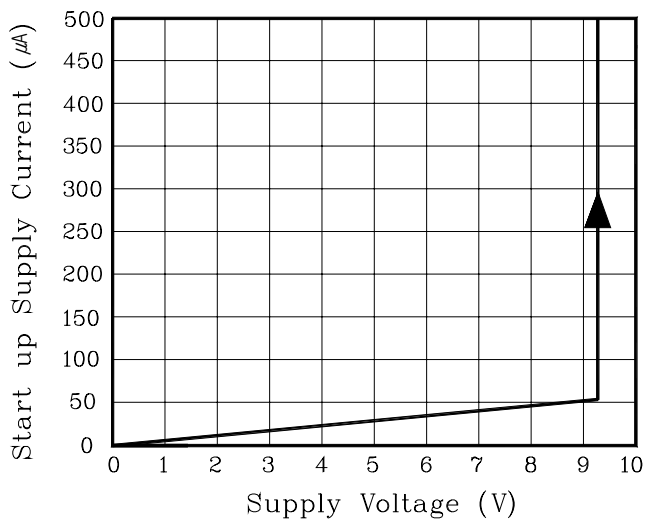

Fig. 2 Operating Supply Current vs. Supply Voltage

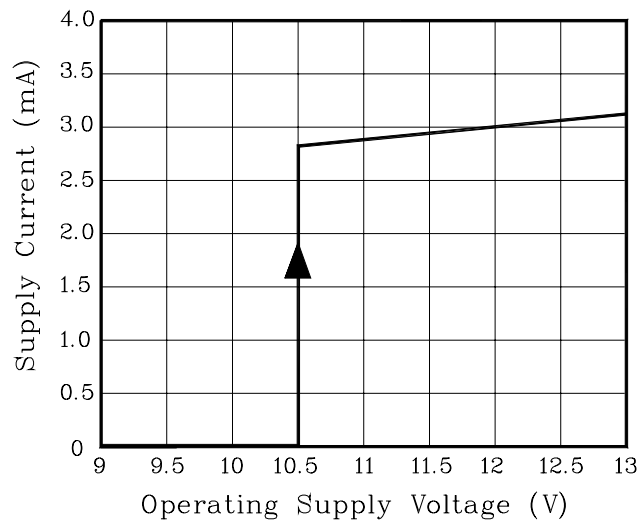

Fig. 3 UVLO Hysteresis vs. Supply Current

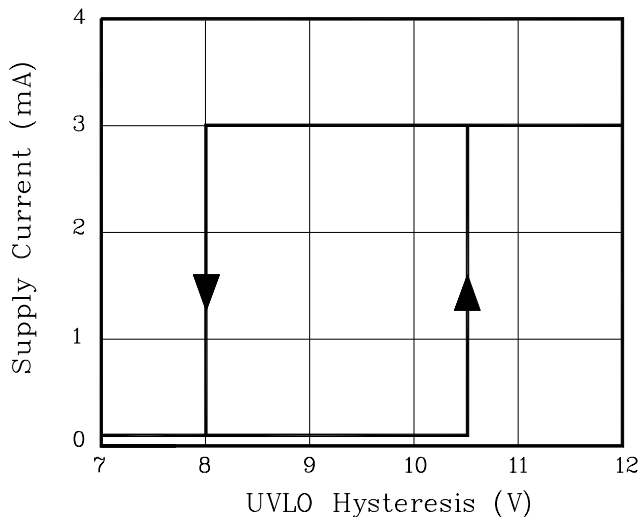

Fig. 4 No Lamp Detect Voltage vs. Ldet Input Voltage

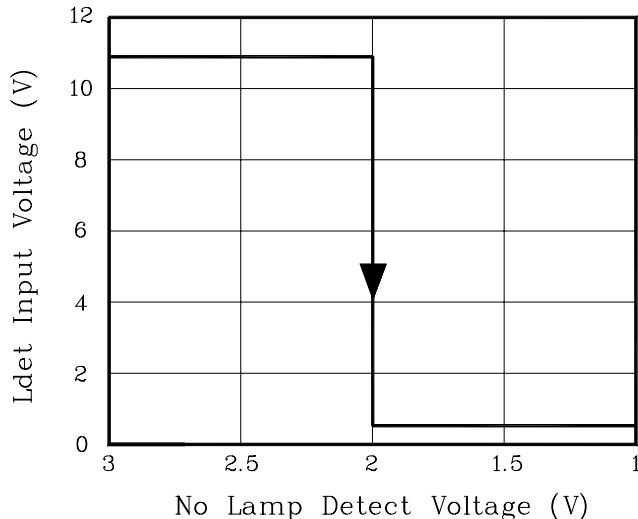
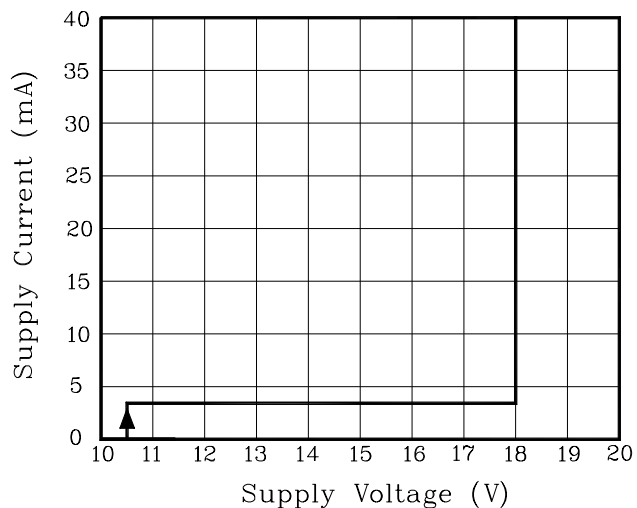

Fig. 5 Supply Voltage vs. Supply Current



The AUK Corp. products are intended for the use as components in general electronic equipment (Office and communication equipment, measuring equipment, home appliance, etc.).

Please make sure that you consult with us before you use these AUK Corp. products in equipments which require high quality and / or reliability, and in equipments which could have major impact to the welfare of human life(atomic energy control, airplane, spaceship, transportation, combustion control, all types of safety device, etc.). AUK Corp. cannot accept liability to any damage which may occur in case these AUK Corp. products were used in the mentioned equipments without prior consultation with AUK Corp..

Specifications mentioned in this publication are subject to change without notice.