

Description

The S6520 contains all of the necessary control circuitry to implement a highly efficient cold cathode fluorescent back-light driver and provides a near sinusoidal output voltage and current waveforms for a CCFL. A specially designed integrated circuit provides all control functions for a current fed push-pull converter and contains two PWM(Pulse Width Modulation) control circuits to drive 4 CCFLs for LCD monitor. The S6520 operates at constant frequency in a PWM mode and it has feed forward control method, this function preventing lamp flickering against input voltage step changing. Therefore, even though input voltage is changed suddenly, the lamp current remains constant because of the feed back and feed forward control. Typical operating frequency ranges between 30kHz to 200kHz, dependent upon the CCFL and transformer characteristics. It provides protection functions such as OLP(Open Lamp Protection), SCP(Short Circuit Protection).

Features

- Complete Dual PWM Power Control Circuitry
- Internal Soft Start for Soft Lamp Ignition
- Enable Function to lock the output off until Out Signal is Operational
- Analog Dimming Function
- Internal Stable 5V Reference Supply
- Open Lamp Protection
- Internal Short Circuit Protection

Ordering Information

Type NO.	Marking	Package Code
S6520P	S6520P	DIP-16

Outline Dimensions

unit : mm

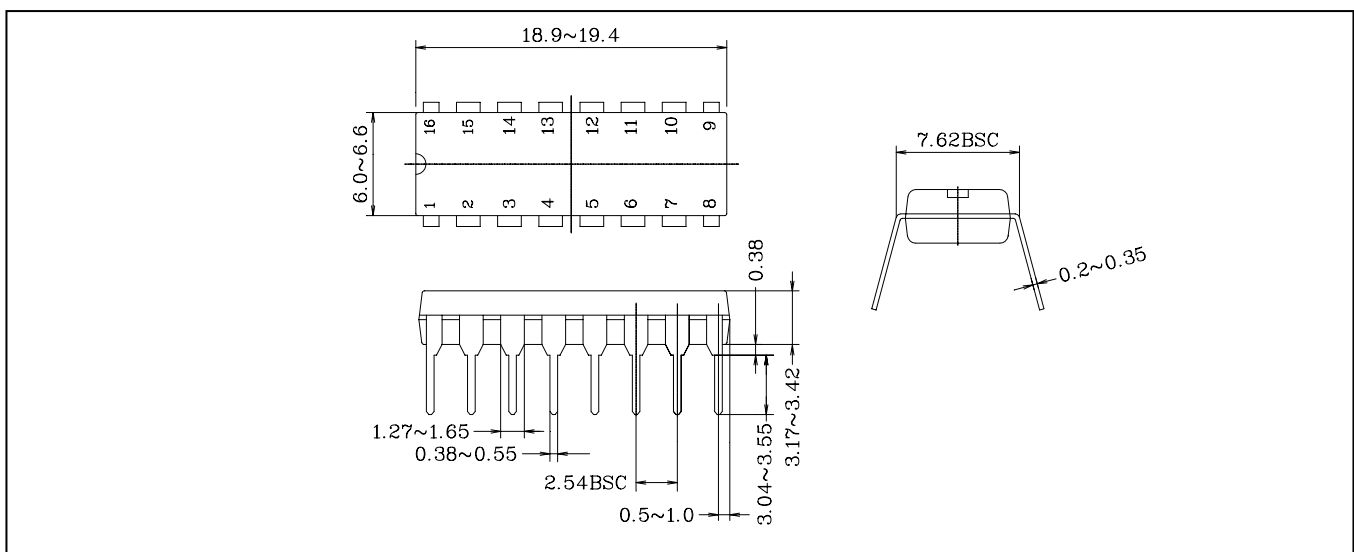

Internal Block Diagram

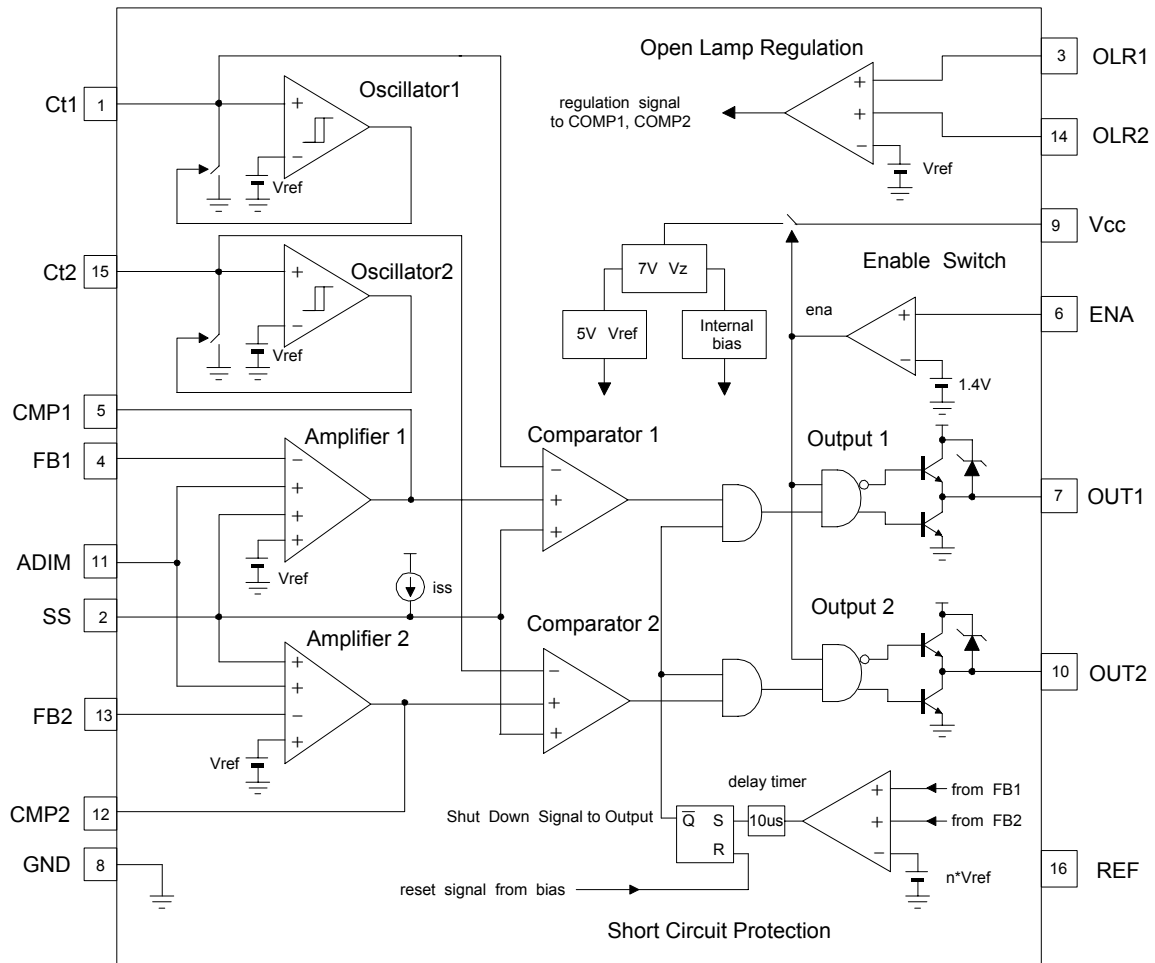

PIN Collection

Pin Number	Symbol	I/O	Pin Function Description
1	CT1	I	Frequency Trimming Capacitor for Main Frequency Setting 1
2	SS	I	Initial Soft Start
3	OLR1	I	Open Lamp Regulation 1
4	FB1	I	Feedback 1 (Error Amplifier Negative Input)
5	CMP1	-	Error Amplifier Output 1
6	ENA	I	ON/OFF Control Pin. TTL Signal is Applicable.
7	OUT1	O	Output Drive1
8	GND	-	Ground
9	VCC	I	Supply Voltage
10	OUT2	O	Output Drive 2
11	ADIM	-	Analog Dimming Input
12	CMP2	-	Error Amplifier Output 2
13	FB2	I	Feedback 2 (Error Amplifier Negative Input)
14	OLR2	I	Open Lamp Regulation 2
15	CT2	I	Frequency Trimming Capacitor for Main Frequency Setting 2
16	REF	O	Reference Voltage (VREF) = 5V

ABSOLUTE MAXIMUM RATINGS

CHARACTERISTICS	SYMBOL	VALUE	UNITS
Supply Voltage	V_{CC}	22	V
Power Dissipation	P_D	1.5	W
Operating Temperature	T_{OPR}	-25~+85	°C
Storage Temperature	T_{STG}	-40~+125	

Electrical Characteristics

$T_a=25^{\circ}\text{C}$, $V_{CC}=10\text{V}$, unless otherwise specified.

Characteristic	Symbol	Test Condition	Min.	Typ.	Max.	Unit
REFERENCE SECTION						
Reference Voltage	V_{ref}	-	4.925	5.0	5.075	V
Line Regulation	$\Delta V_{ref. LINE}$	$8 \leq V_{CC} \leq 20$	-	2.0	25	mV
Load Regulation	$\Delta V_{ref. LOAD}$	$0\text{mA} \leq I_{ref} \leq 5\text{mA}$	-	1.0	15	mV
Temperature Coefficient (note 1)	$\Delta V_{ref}/\Delta T$	$-25^{\circ}\text{C} \leq T_a \leq 85^{\circ}\text{C}$	-	0.01	-	%/°C
ERROR AMPLIFIER SECTION (EA1, EA2)						
Inverting Reference Voltage	$V_{ref(EA)}$	-	2.4	2.5	2.6	V
Input Bias Current	$I_{B(EA)}$	$V_{CMP}=2.5\text{V}$	-	-0.1	-1.0	uA
Output Sink Current	I_{SINK}	$V_{CMP}=2.5\text{V}$	0.3	2	-	mA
Output Source Current	I_{SOURCE}	$V_{CMP}=2.5\text{V}$	-0.3	-2	-	mA
Dimming Input Voltage Range	V_{DIM}	-	0	-	2.5	V
SOFT START SECTION						
Initial Soft Start Current	I_{SS}	-	7.5	12.5	17	uA
Soft Start Limit Voltage	V_{SSL}	-	4.1	4.7	5.3	V
PROTECTION SECTION (SCP1, SCP2 & OLR1, OLR2)						
SCP Threshold Voltage	V_{SCP}	-	2.55	2.7	2.85	V
OLR Threshold Voltage	V_{OLR}	-	2.35	2.5	2.65	V
On/Off Threshold Voltage	V_{ENA}	-	1.1	1.4	1.7	V
OSCILLATOR SECTION (OSC1, OSC2)						
Oscillator Frequency	F_O	$R_t=50\text{k}$, $C_t=680\text{pF}$	45	50	55	kHz

Electrical Characteristics(Continued)

Ta=25°C, V_{CC} = 10V, unless otherwise specified.

Characteristic	Symbol	Test Condition	Min.	Typ.	Max.	Unit
OUTPUT SECTION (OUT1, OUT2)						
P-CH Output High Voltage	V _{POH}	I _{SINK} =10mA	V _{CC} -0.9	V _{CC} -0.7	V _{CC} -0.4	V
P-CH Output Low Voltage	V _{POL}	I _{SOURCE} =10mA	V _{CC} -7.5	V _{CC} -6.0	V _{CC} -4.5	V
Output Rising Time (Note1)	t _R	C _{OUT} =0.5nF	-	200	300	nsec
Output Falling Time (Note1)	t _F	C _{OUT} =0.5nF	-	100	200	nsec
START SECTION						
Stand by Current 8V	I _{SB8}	-	-	10	30	uA
Stand by Current 20V	I _{SB20}	-	-	20	60	uA
Operating Current	I _{CC}	-	-	4	6	mA

* Note 1. These parameters, although guaranteed, are not 100% tested in production

Electrical Characteristic Curves

Fig. 1 $V_{CC} - I_{SB}$

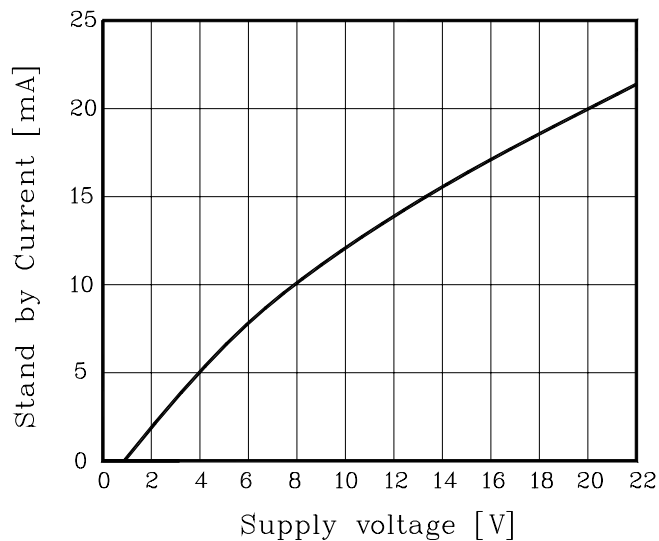

Fig. 2 $V_{CC} - I_{CC}$

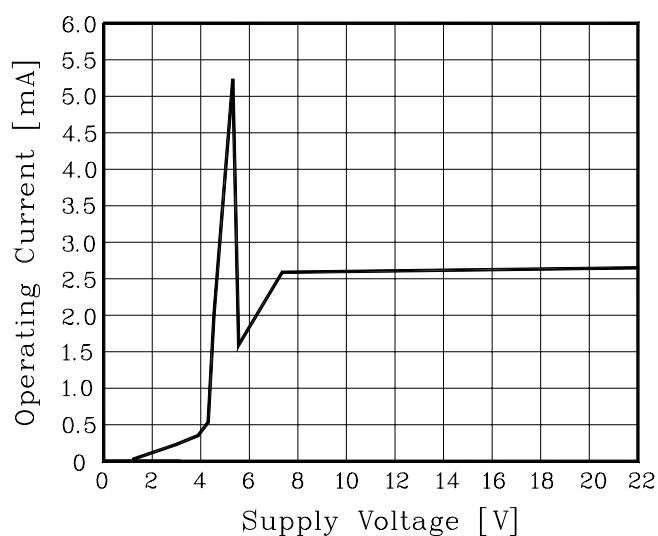

Fig. 3 $V_{CC} - V_{ref}$

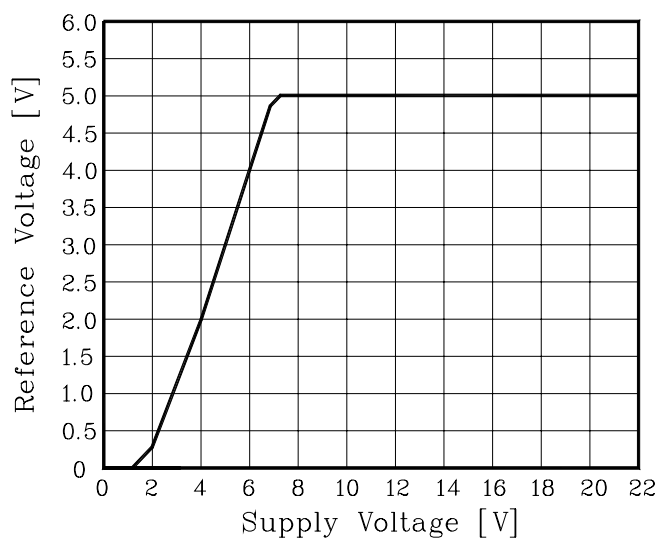

Fig. 4 $V_{ref(EA)} - V_{CMP}$

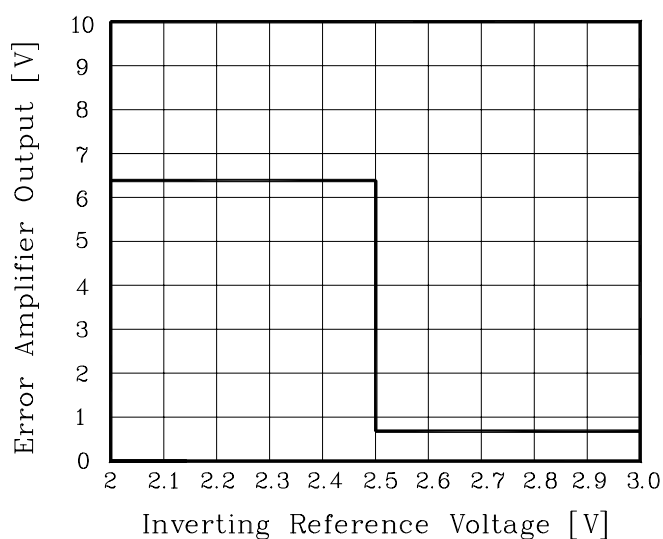

Fig. 7 $V_{SCP} - V_{OUT}$

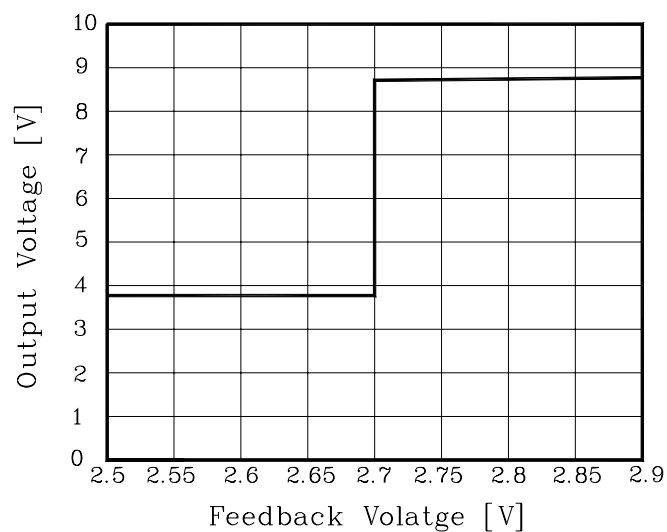
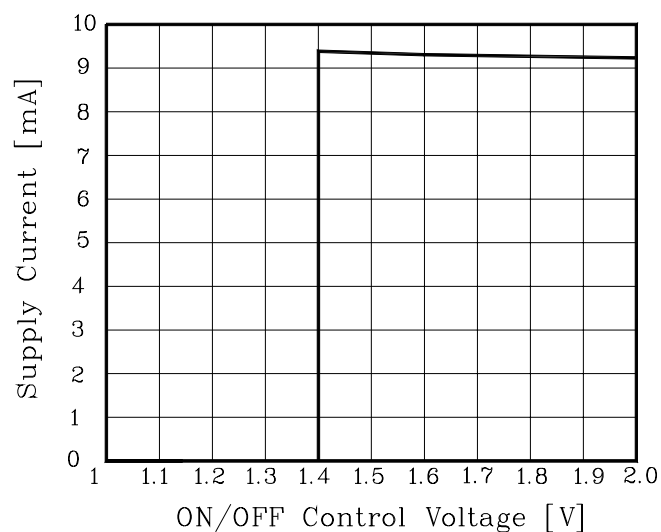

Fig. 8 $V_{ENA} - I_{CC}$



These AUK products are intended for usage in general electronic equipments(Office and communication equipment, measuring equipment, domestic electrification, etc.).

Please make sure that you consult with us before you use these AUK products in equipments which require high quality and/or reliability, and in equipments which could have major impact to the welfare of human life(atomic energy control, airplane, spaceship, traffic signal, combustion central, all types of safety device, etc.).

AUK cannot accept liability to any damage which may occur in case these AUK products were used in the mentioned equipments without prior consultation with AUK.