

Descriptions

This series of fixed-negative-voltage monolithic integrated-circuit voltage regulators is designed to complement series S7800 in a wide range of applications. These applications include on-card regulation for elimination of noise and distribution problems associated with single point regulation. Each of these regulators can deliver up to 1.0 amperes of output current. The internal current limiting and thermal shutdown features of these regulators make them essentially immune to overload. In addition to use as fixed-voltage regulators, these devices can be used with external components to obtain adjustable output voltages and current and also as the power pass element in precision regulators.

Features

- Output Current UP to 1.0A
- Internal Thermal Overload Protection
- Internal Short-Circuit Current Limiting
- No External Components
- Output Transistor Safe-Area Compensations

Ordering Information

Type NO.	Marking	Package Code
S79xxPIC	S79□□PI	TO-220F-3SL

□□: Voltage Code (05:-5V, 08:-8V, 09:-9V, 12:-12V, 15:-15V)

Outline Dimensions

unit : mm

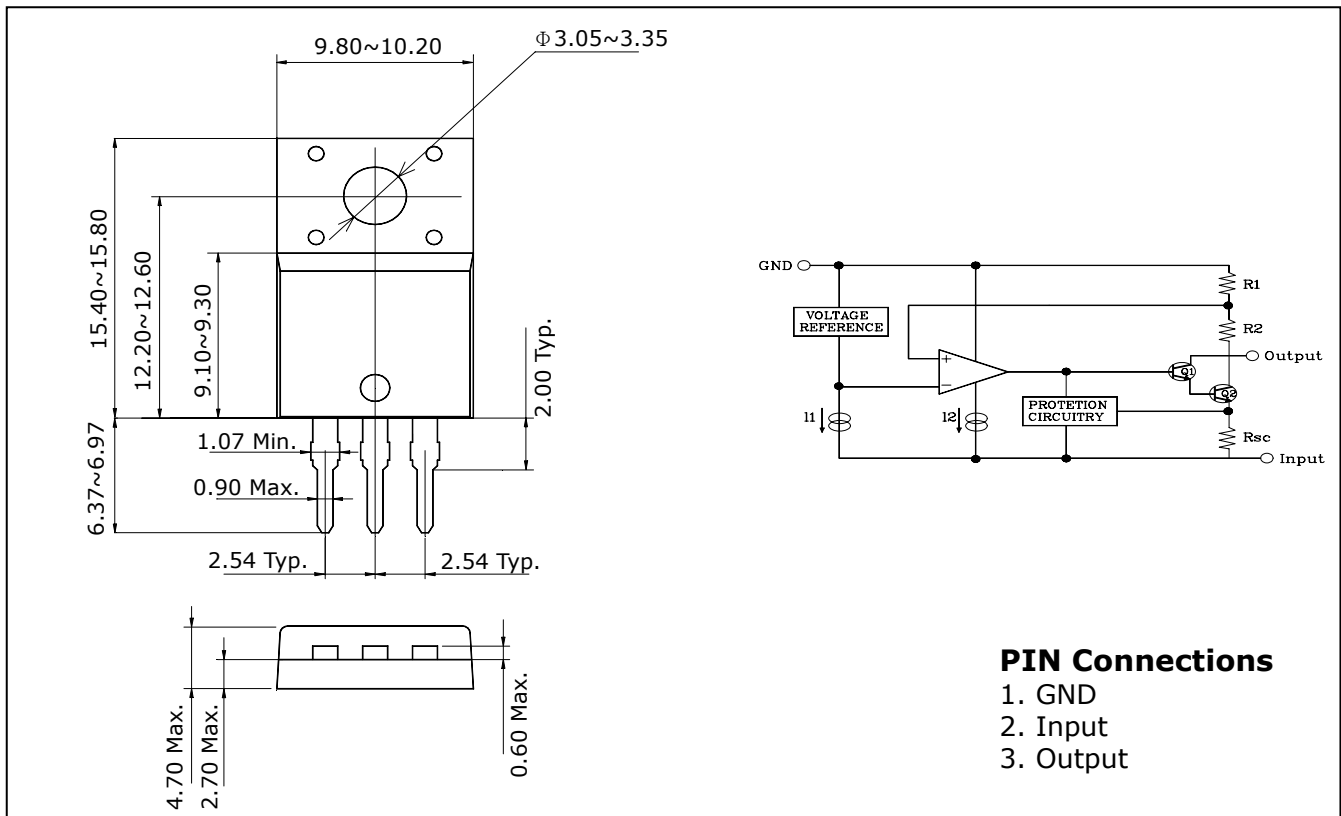

PIN Connections

1. GND
2. Input
3. Output

Absolute Maximum Ratings

Ta=25°C

Characteristic	Symbol	Ratings	Unit
Operating Input voltage	V _{IN}	-35	V
Power Dissipation (Tc=25°C)	P _D	20.8	W
Power Dissipation (without Heatsink)	P _D	2.0	W
Operating Junction Temperature	T _J	-30 ~ 125	°C
Storage Temperature	T _{STG}	-55 ~ 150	°C

Electrical Characteristics

(T_j = 0 to 125°C, Vin = -10V, Iout=500mA, unless otherwise specified.)

Characteristic	Symbol	Test Condition *		S7905PIC			Unit
				Min.	Typ.	Max.	
Output Voltage**	V _{OUT}		T _j = 25°C	-4.8	-5.0	-5.2	V
		I _{OUT} =5mA ~ 1A V _{IN} =-7.0V ~ -20V, P _D ≤ 15W		-4.75	-5.0	-5.25	
Line Regulation	ΔV _{OUT}	V _{IN} =-7.0V ~ -25V	T _j = 25°C	-	12.5	50	mV
		V _{IN} =-8.0V ~ -12V		-	4	15	
Load Regulation	ΔV _{OUT}	I _{OUT} =5mA ~ 1.0A	T _j = 25°C	-	15	100	mV
		I _{OUT} =250mA ~ 750mA		-	5	50	
Bias Current	I _B		T _j = 25°C	-	1.5	2.0	mA
Bias Current Change	ΔI _B	V _{IN} = -7.0V ~ -25V		-	0.15	0.5	mA
		I _{OUT} = 5mA ~ 1A		-	0.08	0.5	
Output Noise Voltage	V _N	f=10Hz ~ 100KHz	T _j = 25°C	-	125	-	uV _{rms}
Ripple Rejection Ratio	RR	f=120Hz, V _{IN} = -8.0V ~ -18V		54	60	-	dB
Dropout Voltage	V _D	I _{OUT} =1A	T _j = 25°C	-	2.0	-	V
Temperature coefficient of output Voltage Drift	T _{CV0}	I _{OUT} =5mA		-	-0.4	-	mV/°C
Peak Output Current	I _{PK}		T _j = 25°C	-	2.1	-	A

* Pulse testing techniques are used to maintain the junction temperature as close to the ambient temperature as possible. Thermal effects must be taken into separately.

** This specification applies only for dc power dissipation permitted by absolute maximum ratings.

Electrical Characteristics

($T_j = 0$ to 125°C , $V_{in} = -14\text{V}$, $I_{out} = 500\text{mA}$, unless otherwise specified.)

Characteristic	Symbol	Test Condition *		S7908PIC			Unit
				Min.	Typ.	Max.	
Output Voltage**	V_{OUT}		$T_j = 25^\circ\text{C}$	-7.7	-8.0	-8.3	V
		$I_{OUT} = 5\text{mA} \sim 1\text{A}$ $V_{IN} = -10.5\text{V} \sim -23\text{V}$, $P_D \leq 15\text{W}$		-7.6	-8.0	-8.4	
Line Regulation	ΔV_{OUT}	$V_{IN} = -10.5\text{V} \sim -25\text{V}$	$T_j = 25^\circ\text{C}$	-	12.5	160	mV
		$V_{IN} = -11.0\text{V} \sim -17\text{V}$		-	4	80	
Load Regulation	ΔV_{OUT}	$I_{OUT} = 5\text{mA} \sim 1.0\text{A}$	$T_j = 25^\circ\text{C}$	-	15	160	mV
		$I_{OUT} = 250\text{mA} \sim 750\text{mA}$		-	5	80	
Bias Current	I_B		$T_j = 25^\circ\text{C}$	-	1.5	2.0	mA
Bias Current Change	ΔI_B	$V_{IN} = -10.5\text{V} \sim -25\text{V}$		-	0.15	1.0	mA
		$I_{OUT} = 5\text{mA} \sim 1\text{A}$		-	0.08	0.5	
Output Noise Voltage	V_N	$f = 10\text{Hz} \sim 100\text{kHz}$	$T_j = 25^\circ\text{C}$	-	200	-	μV_{rms}
Ripple Rejection Ratio	RR	$f = 120\text{Hz}$, $V_{IN} = -11.5\text{V} \sim -21.5\text{V}$		54	60	-	dB
Dropout Voltage	V_D	$I_{OUT} = 1\text{A}$	$T_j = 25^\circ\text{C}$	-	2.0	-	V
Temperature coefficient of output Voltage Drift	T_{CVO}	$I_{OUT} = 5\text{mA}$	$T_j = 25^\circ\text{C}$	-	-0.6	-	$\text{mV}/^\circ\text{C}$
Peak Output Current	I_{PK}		$T_j = 25^\circ\text{C}$	-	2.1	-	A

* Pulse testing techniques are used to maintain the junction temperature as close to the ambient temperature as possible. Thermal effects must be taken into separately.

** This specification applies only for dc power dissipation permitted by absolute maximum ratings.

Electrical Characteristics

($T_j = 0$ to 125°C , $V_{in} = -15\text{V}$, $I_{out} = 500\text{mA}$, unless otherwise specified.)

Characteristic	Symbol	Test Condition *		S7909PIC			Unit
				Min.	Typ.	Max.	
Output Voltage**	V_{OUT}		$T_j = 25^\circ\text{C}$	-8.70	-9.0	-9.30	V
		$I_{OUT} = 5\text{mA} \sim 1\text{A}$ $V_{IN} = -11.5\text{V} \sim -23\text{V}$, $P_D \leq 15\text{W}$		-8.60	-9.0	-9.40	
Line Regulation	ΔV_{OUT}	$V_{IN} = -10.5\text{V} \sim -25\text{V}$	$T_j = 25^\circ\text{C}$	-	10	180	mV
		$V_{IN} = -110\text{V} \sim -17\text{V}$		-	5	90	
Load Regulation	ΔV_{OUT}	$I_{OUT} = 5\text{mA} \sim 1.0\text{A}$	$T_j = 25^\circ\text{C}$	-	12	180	mV
		$I_{OUT} = 250\text{mA} \sim 750\text{mA}$		-	4	90	
Bias Current	I_B		$T_j = 25^\circ\text{C}$	-	3	6	mA
Bias Current Change	ΔI_B	$V_{IN} = -11.5\text{V} \sim -25\text{V}$		-	0.1	1.0	mA
		$I_{OUT} = 5\text{mA} \sim 1\text{A}$		-	0.08	0.5	
Output Noise Voltage	V_N	$f = 10\text{Hz} \sim 100\text{KHz}$	$T_j = 25^\circ\text{C}$	-	175	-	μV_{rms}
Ripple Rejection Ratio	RR	$f = 120\text{Hz}$, $V_{IN} = -9.0\text{V} \sim -19\text{V}$		54	60	-	dB
Dropout Voltage	V_D	$I_{OUT} = 1\text{A}$	$T_j = 25^\circ\text{C}$	-	2.0	-	V
Temperature coefficient of output Voltage Drift	T_{CVO}	$I_{OUT} = 5\text{mA}$	$T_j = 25^\circ\text{C}$	-	-0.4	-	$\text{mV}/^\circ\text{C}$
Peak Output Current	I_{PK}		$T_j = 25^\circ\text{C}$	-	2.1	-	A

* Pulse testing techniques are used to maintain the junction temperature as close to the ambient temperature as possible. Thermal effects must be taken into separately.

** This specification applies only for dc power dissipation permitted by absolute maximum ratings.

Electrical Characteristics

($T_j = 0$ to 125°C , $V_{in} = -19\text{V}$, $I_{out} = 500\text{mA}$, unless otherwise specified.)

Characteristic	Symbol	Test Condition *		S7912PIC			Unit
				Min.	Typ.	Max.	
Output Voltage**	V_{OUT}		$T_j = 25^\circ\text{C}$	-11.5	-12.0	-12.5	V
		$I_{OUT} = 5\text{mA} \sim 1\text{A}$ $V_{IN} = -14.5\text{V} \sim -27\text{V}$, $P_D \leq 15\text{W}$		-11.4	-12.0	-12.6	
Line Regulation	ΔV_{OUT}	$V_{IN} = -14.5\text{V} \sim -30\text{V}$	$T_j = 25^\circ\text{C}$	-	5	80	mV
		$V_{IN} = -16.0\text{V} \sim -22\text{V}$		-	3	30	
Load Regulation	ΔV_{OUT}	$I_{OUT} = 5\text{mA} \sim 1.0\text{A}$	$T_j = 25^\circ\text{C}$	-	15	200	mV
		$I_{OUT} = 250\text{mA} \sim 750\text{mA}$		-	5	75	
Bias Current	I_B		$T_j = 25^\circ\text{C}$	-	2.0	3.0	mA
Bias Current Change	ΔI_B	$V_{IN} = -14.5\text{V} \sim -30\text{V}$		-	0.04	0.5	mA
		$I_{OUT} = 5\text{mA} \sim 1\text{A}$		-	0.08	0.5	
Output Noise Voltage	V_N	$f = 10\text{Hz} \sim 100\text{KHz}$,	$T_j = 25^\circ\text{C}$	-	300	-	μV_{rms}
Ripple Rejection Ratio	RR	$f = 120\text{Hz}$, $V_{IN} = -15\text{V} \sim -25\text{V}$		54	60	-	dB
Dropout Voltage	V_D	$I_{OUT} = 1\text{A}$	$T_j = 25^\circ\text{C}$	-	2.0	-	V
Temperature coefficient of output Voltage Drift	T_{CVO}	$I_{OUT} = 5\text{mA}$	$T_j = 25^\circ\text{C}$	-	-0.8	-	$\text{mV}/^\circ\text{C}$
Peak Output Current	I_{PK}		$T_j = 25^\circ\text{C}$	-	2.1	-	A

* Pulse testing techniques are used to maintain the junction temperature as close to the ambient temperature as possible. Thermal effects must be taken into separately.

** This specification applies only for dc power dissipation permitted by absolute maximum ratings.

Electrical Characteristics

($T_j = 0$ to 125°C , $V_{in} = -23\text{V}$, $I_{out} = 500\text{mA}$, unless otherwise specified.)

Characteristic	Symbol	Test Condition *		S7915PIC			Unit
				Min.	Typ.	Max.	
Output Voltage**	V_{OUT}		$T_j = 25^\circ\text{C}$	-14.4	-15.0	-15.6	V
		$I_{OUT} = 5\text{mA} \sim 1\text{A}$ $V_{IN} = -17.5\text{V} \sim -30\text{V}$, $P_D \leq 15\text{W}$		-14.25	-15.0	-15.75	
Line Regulation	ΔV_{OUT}	$V_{IN} = -17.5\text{V} \sim -30\text{V}$	$T_j = 25^\circ\text{C}$	-	5	100	mV
		$V_{IN} = -20\text{V} \sim -26\text{V}$		-	3	50	
Load Regulation	ΔV_{OUT}	$I_{OUT} = 5\text{mA} \sim 1.0\text{A}$	$T_j = 25^\circ\text{C}$	-	15	200	mV
		$I_{OUT} = 250\text{mA} \sim 750\text{mA}$		-	5	75	
Bias Current	I_B		$T_j = 25^\circ\text{C}$	-	2.0	3.0	mA
Bias Current Change	ΔI_B	$V_{IN} = -17.5\text{V} \sim -30\text{V}$		-	0.04	0.5	mA
		$I_{OUT} = 5\text{mA} \sim 1\text{A}$		-	0.08	0.5	
Output Noise Voltage	V_N	$f = 10\text{Hz} \sim 100\text{KHz}$,	$T_j = 25^\circ\text{C}$	-	375	-	μV_{rms}
Ripple Rejection Ratio	RR	$f = 120\text{Hz}$, $V_{IN} = -18.5\text{V} \sim -28.5\text{V}$		54	60	-	dB
Dropout Voltage	V_D	$I_{OUT} = 1\text{A}$	$T_j = 25^\circ\text{C}$	-	2.0	-	V
Temperature coefficient of output Voltage Drift	T_{CVO}	$I_{OUT} = 5\text{mA}$	$T_j = 25^\circ\text{C}$	-	-1.0	-	$\text{mV}/^\circ\text{C}$
Peak Output Current	I_{PK}		$T_j = 25^\circ\text{C}$	-	2.1	-	A

* Pulse testing techniques are used to maintain the junction temperature as close to the ambient temperature as possible. Thermal effects must be taken into separately.

** This specification applies only for dc power dissipation permitted by absolute maximum ratings.

■ Test circuit

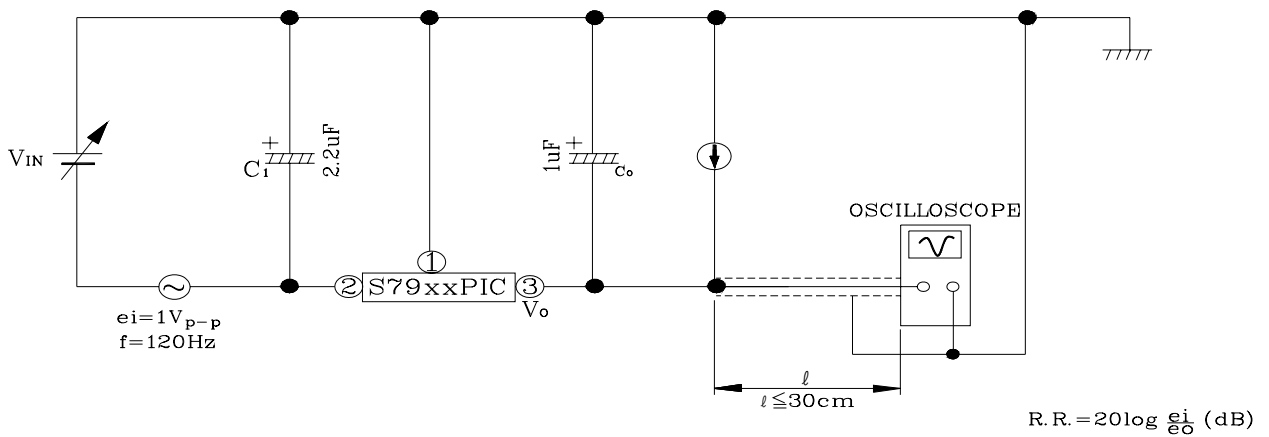
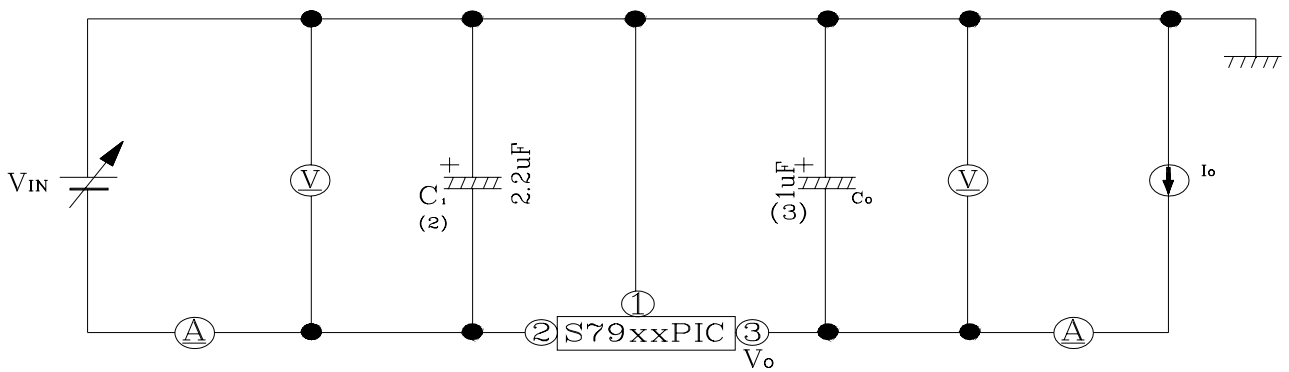
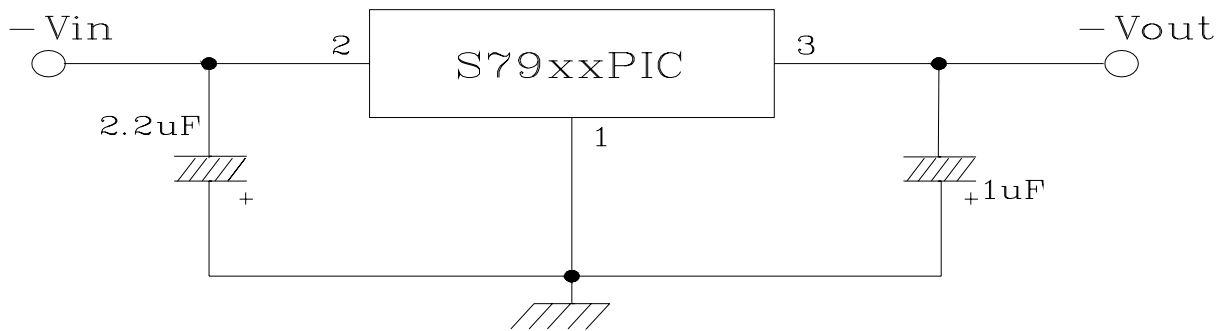

Electrical Characteristic Curves

Fig. 1 $V_{OUT} - V_{IN}$

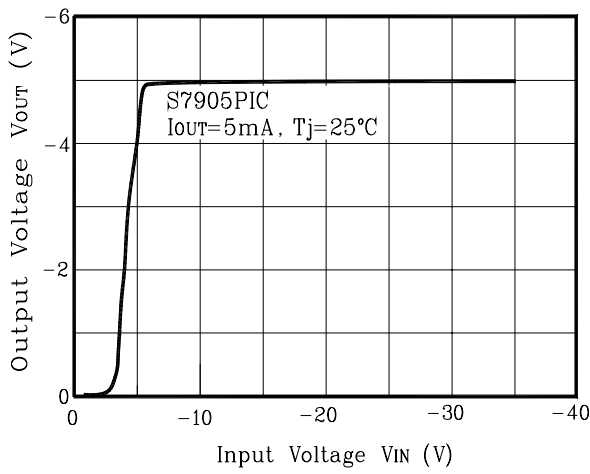

Fig. 2 $V_D - T_a$

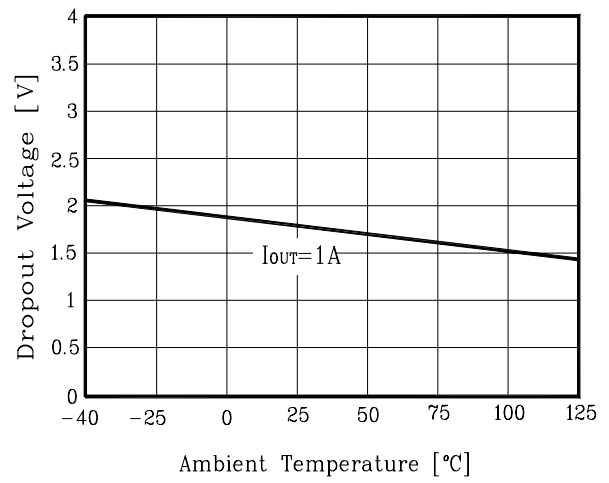

Fig. 3 $I_B - T_j$

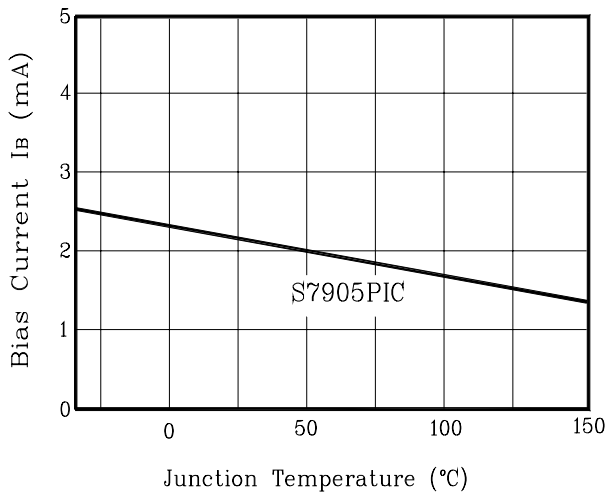

Fig. 4 $V_{OUT} - T_j$

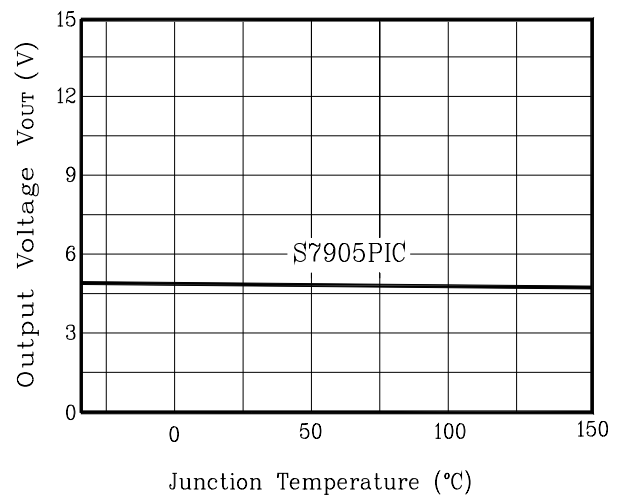
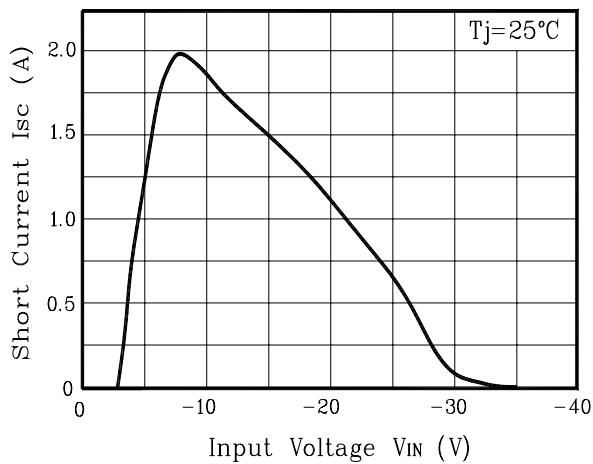

Fig. 5 $I_{SC} - V_{IN}$



These AUK products are intended for usage in general electronic equipments(Office and communication equipment, measuring equipment, domestic electrification, etc.).

Please make sure that you consult with us before you use these AUK products in equipments which require high quality and/or reliability, and in equipments which could have major impact to the welfare of human life(atomic energy control, airplane, spaceship, traffic signal, combustion central, all types of safety device, etc.).

AUK cannot accept liability to any damage which may occur in case these AUK products were used in the mentioned equipments without prior consultation with AUK.