

**Description**

- High speed switching application.
- Analog switch application.

**Features**

- 2.5V Gate drive.
- Low threshold voltage :  $V_{th} = 0.5 \sim 1.5V$ .
- Two STK1828 Chips in SOT-563F Package.

**Ordering Information**

Type NO.	Marking	Package Code
SUF621EF	H	SOT-563F

**Outline Dimensions**

unit : mm

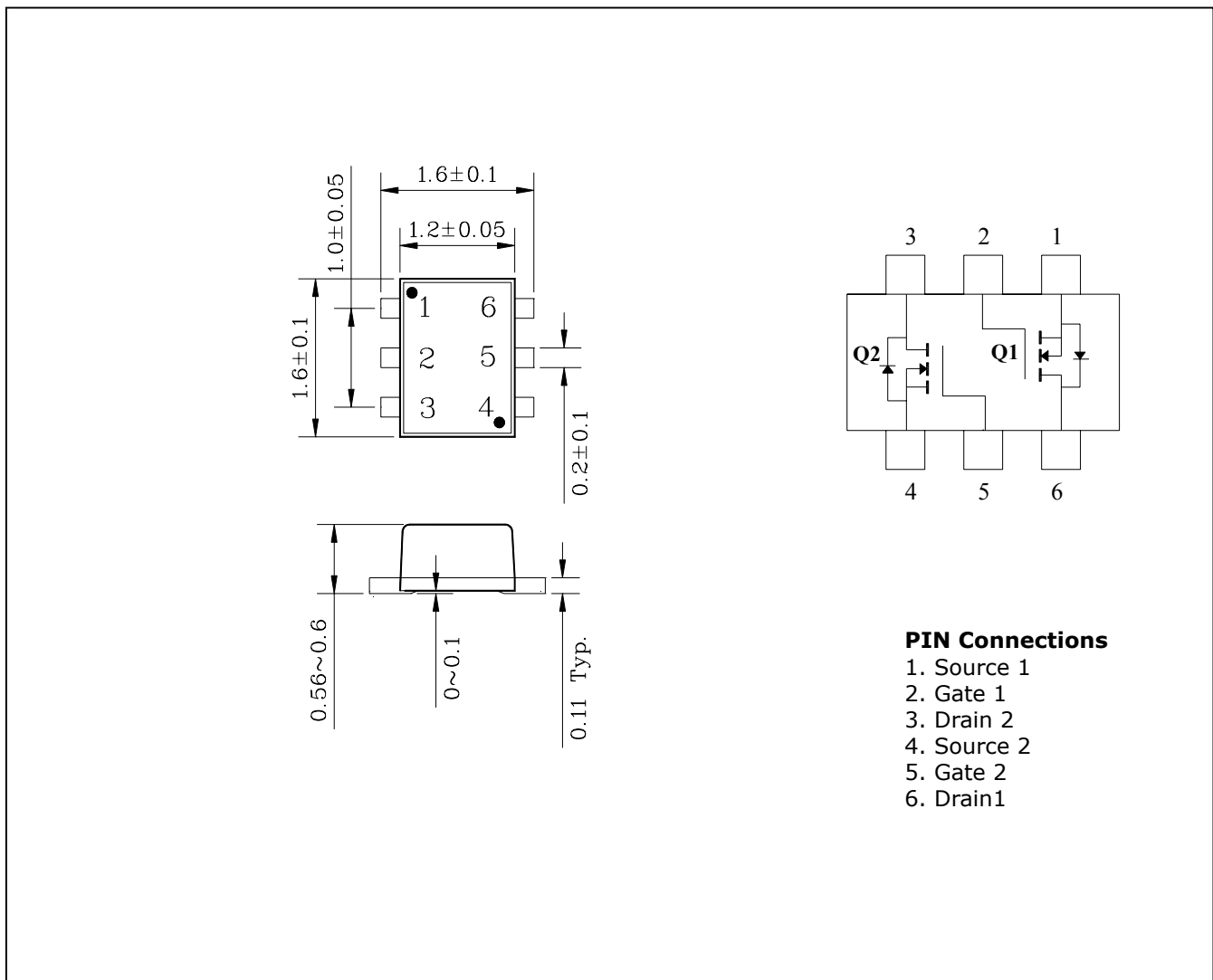

## Absolute maximum ratings (Q1,Q2 Common)

(Ta=25°C)

Characteristic	Symbol	Ratings	Unit
Drain-Source voltage	$V_{DS}$	20	V
Gate-Source voltage	$V_{GSS}$	10	V
DC Drain current	$I_D$	50	mA
Drain Power dissipation	$P_D$	100	mW
Channel temperature	$T_{ch}$	150	°C
Storage temperature range	$T_{stg}$	-55~150	°C

## Electrical Characteristics (Q1,Q2 Common)

(Ta=25°C)

Characteristic	Symbol	Test Condition	Min.	Typ.	Max.	Unit
Drain-Source breakdown voltage	$BV_{DSS}$	$I_D=100\mu A, V_{GS}=0$	20			V
Gate-Threshold voltage	$V_{th}$	$I_D=0.1mA, V_{DS}=3V$	0.5		1.5	V
Drain cut-off current	$I_{DSS}$	$V_{DS}=20V, V_{GS}=0$			1	$\mu A$
Gate leakage current	$I_{GSS}$	$V_{GS}=10V, V_{DS}=0$			1	$\mu A$
Drain-Source on-resistance	$R_{DS(ON)}$	$V_{GS}=2.5V, I_D=10mA$		20	40	$\Omega$
Forward transfer admittance	$ Y_{fs} $	$V_{DS}=3V, I_D=10mA$	20			mS
Input capacitance	$C_{iss}$	$V_{DS}=3V, V_{GS}=0, f=1MHz$		5.5		pF
Output capacitance	$C_{oss}$	$V_{DS}=3V, V_{GS}=0, f=1MHz$		6.5		pF
Reverse Transfer capacitance	$C_{rss}$	$V_{DS}=3V, V_{GS}=0, f=1MHz$		1.6		pF
Turn-on time	$t_{on}$	$V_{DD}=3V, I_D=10mA$ $V_{GEN}=0\sim 2.5V$		0.14		$\mu s$
Turn-off time	$t_{off}$	$V_{DD}=3V, I_D=10mA$ $V_{GEN}=0\sim 2.5V$		0.14		$\mu s$

### \* Switching Time Test Circuit

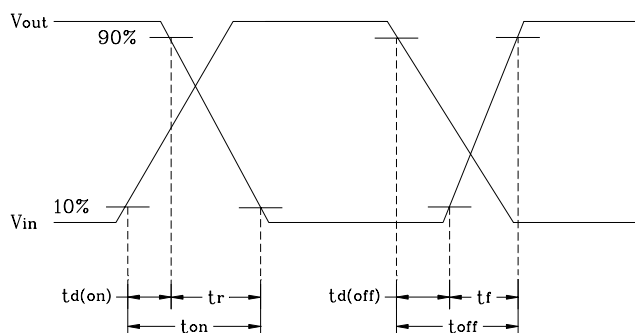
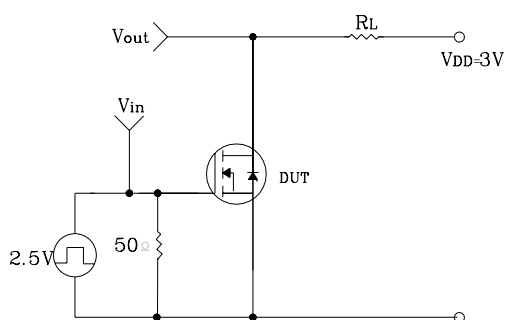

Electrical Characteristic Curves

Fig.1 Id - Vds

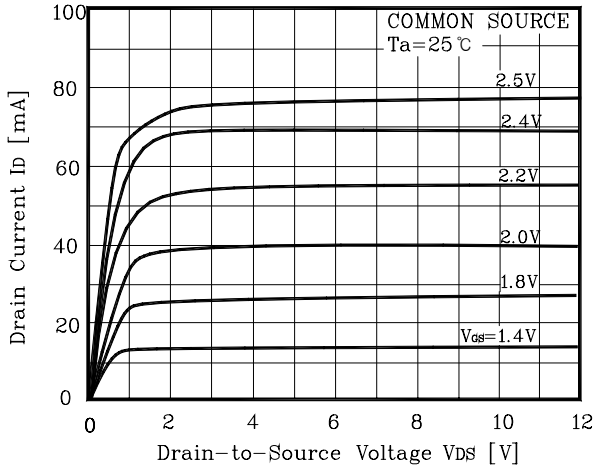

Fig.2 Pd - Ta

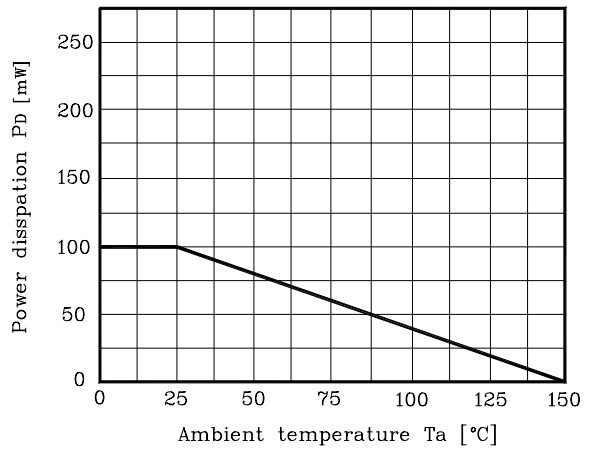

Fig.3 IdR - Vds

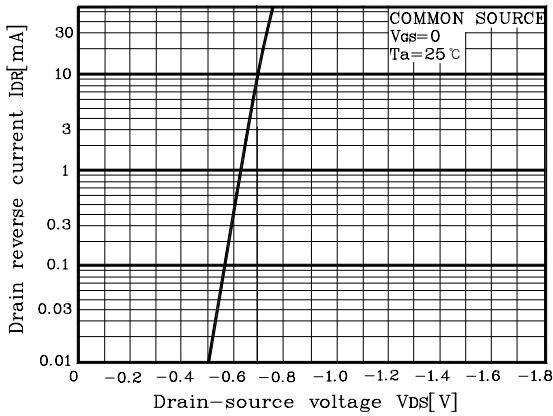

Fig.4 Id - Vgs

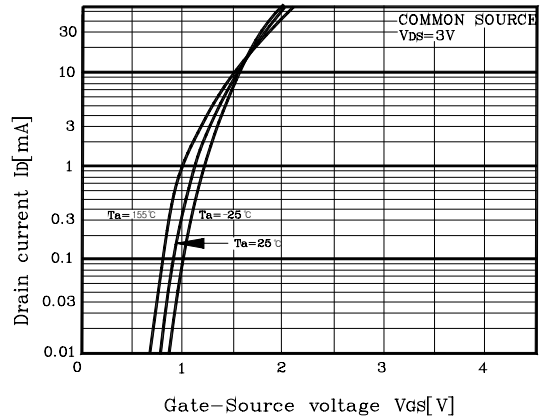

Fig.5 |Yfs| - Id

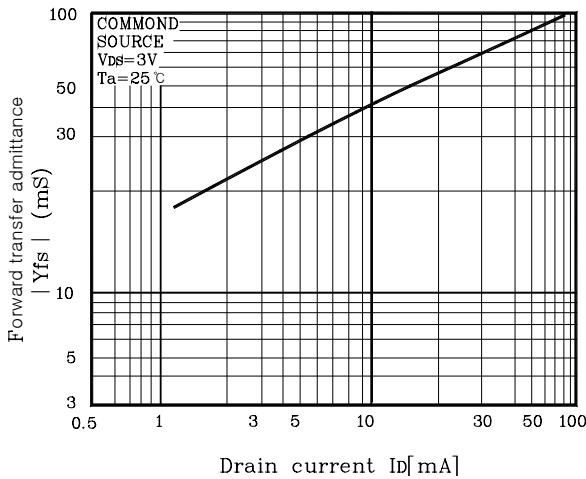
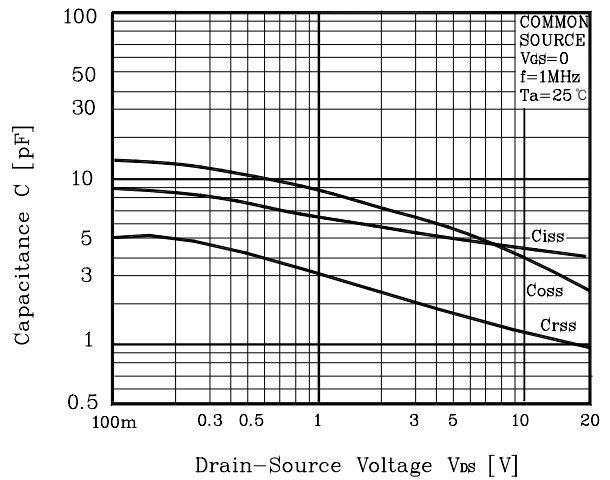

Fig.6 C - Vds



Electrical Characteristic Curves

Fig.7 V<sub>DS</sub> - I<sub>D</sub>

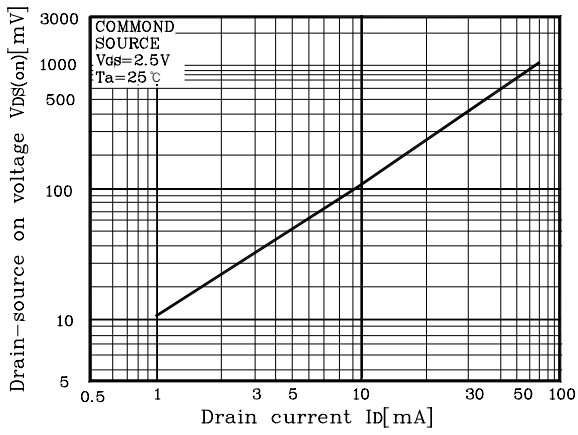

Fig.8 t - I<sub>D</sub>

