

Lithium Ion Battery Application.
Notebook PC , Motor drive Application.

Features

- Low C_{rss} : $C_{rss}=36\text{pF(Typ.)}$
- Low gate charge : $Q_g=4.2\text{nC(Typ.)}$
- Low $R_{DS(on)}$: $R_{DS(on)}=24\text{m}\Omega\text{(Typ.)}$
- Low $V_{GS(th)}$: $V_{GS(th)}=1.0\sim 3.0\text{V}$

Ordering Information

Type NO.	Marking	Package Code
SUF1002	SUF1002	SOP-8

Outline Dimensions

unit : mm

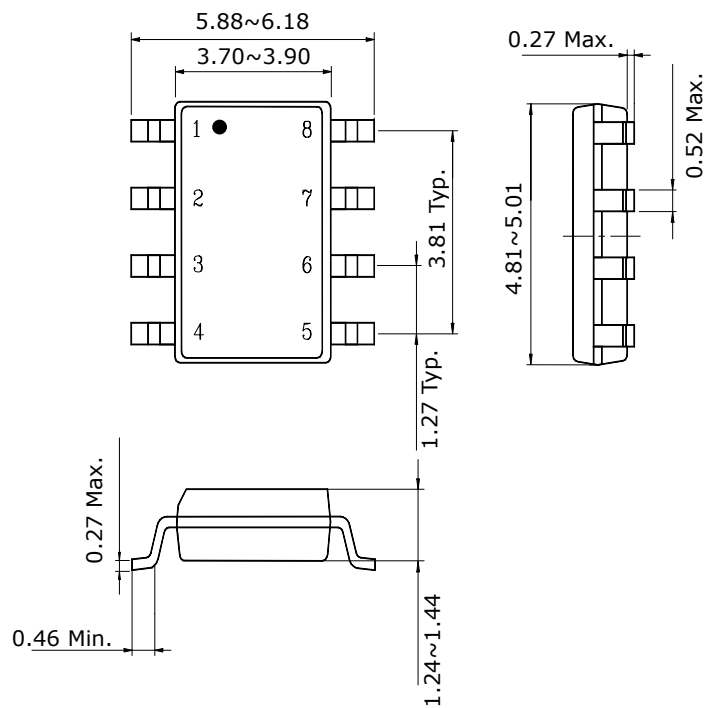

Block Diagram

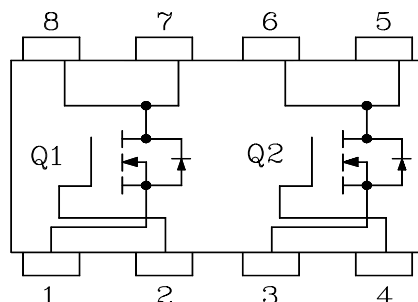

PIN Connections

1. Source 1
2. Gate 1
3. Source 2
4. Gate 2
5. Drain 2
6. Drain 1
7. Drain 1
8. Drain 1

Absolute maximum ratings

(Ta=25°C)

Characteristic	Symbol	Rating	Unit
Drain-source voltage	V_{DSS}	30	V
Gate-source voltage	V_{GSS}	±20	V
Drain current (DC)	I_D	5.8	A
Drain current (Pulsed) *	I_{DP}	23.2	A
Total Power dissipation **	P_D	2.0	W
Avalanche current (Single) ②	I_{AS}	5.8	A
Single pulsed avalanche energy ②	E_{AS}	72	mJ
Avalanche current (Repetitive) ①	I_{AR}	5.8	A
Repetitive avalanche energy ①	E_{AR}	3.4	mJ
Junction temperature	T_J	150	°C
Storage temperature range	T_{stg}	-55~150	

* Limited by maximum junction temperature

** Device mounted on a glass-epoxy board

Characteristic		Symbol	Typ.	Max	Unit
Thermal resistance	Junction-ambient	$R_{th(J-a)}$	62.5		°C/W

Electrical Characteristics

(Ta=25°C)

Characteristic	Symbol	Test Condition	Min.	Typ.	Max.	Unit	
Drain-source breakdown voltage	BV_{DSS}	$I_D=250\mu A, V_{GS}=0$	30	-	-	V	
Gate threshold voltage	$V_{GS(th)}$	$I_D=250\mu A, V_{DS}=V_{GS}$	1.0	-	3.0	V	
Drain-source cut-off current	I_{DSS}	$V_{DS}=30V, V_{GS}=0V$	-	-	1	μA	
Gate leakage current	I_{GSS}	$V_{DS}=0V, V_{GS}=\pm 20V$	-	-	± 100	nA	
Drain-source on-resistance	$R_{DS(on)}$	$V_{GS}=10V, I_D=2.9A$	-	24	30	m Ω	
		$V_{GS}=5.0V, I_D=2.9A$	-	28	34	m Ω	
Forward transfer conductance ④	g_{fs}	$V_{DS}=5V, I_D=5.8A$	-	12	-	S	
Input capacitance	C_{iss}	$V_{GS}=0V, V_{DS}=10V, f=1MHz$	-	370	560	pF	
Output capacitance	C_{oss}		-	60	90		
Reverse transfer capacitance	C_{rss}		-	36	54		
Turn-on delay time	$t_{d(on)}$	$V_{DD}=15V, I_D=5.8A, R_G=10\Omega$	-	1.2	-	ns	
Rise time	t_r		-	1.1	-		
Turn-off delay time	$t_{d(off)}$		③④	-	2.5		-
Fall time	t_f		-	1.1	-		
Total gate charge	Q_g	$V_{DS}=15V, V_{GS}=5V, I_D=5.8A$	-	4.2	6.3	nC	
Gate-source charge	Q_{gs}		③④	-	0.9		1.4
Gate-drain charge	Q_{gd}		-	-	1.4		2.1

Source-Drain Diode Ratings and Characteristics

(Ta=25°C)

Characteristic	Symbol	Test Condition	Min	Typ	Max	Unit
Source current	I_S	Integral reverse diode in the MOSFET	-	-	1.5	A
Source current(Plused) ①	I_{SM}		-	-	6.0	
Forward voltage ④	V_{SD}	$V_{GS}=0V, I_S=1.5A$	-	-	1.2	V
Reverse recovery time	t_{rr}	$I_S=1.5A, di_s/dt=100A/us$	-	90	-	ns
Reverse recovery charge	Q_{rr}		-	0.5	-	μC

Note ;

- ① Repetitive Rating : Pulse Width Limited by Maximum Junction Temperature
- ② $L=3.4mH, I_{AS}=5.8A, V_{DD}=15V, R_G=25\Omega$
- ③ Pulse Test : Pulse Width < 300us, Duty cycle ≤ 2%
- ④ Essentially independent of operating temperature

Electrical Characteristic Curves

Fig. 1 $I_D - V_{DS}$

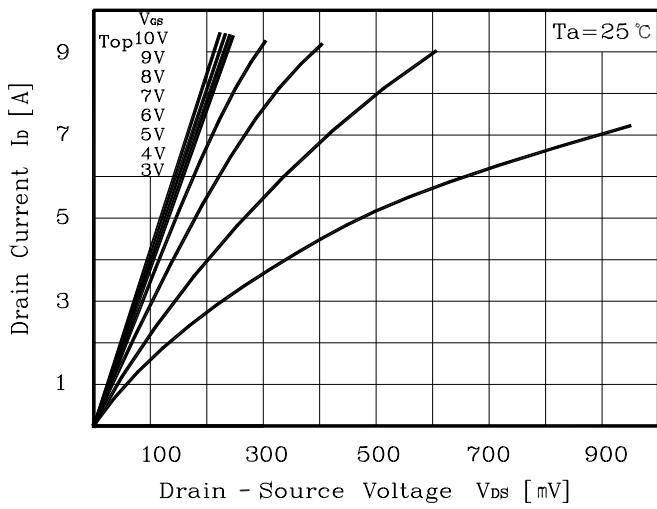

Fig. 2 $I_D - V_{GS}$

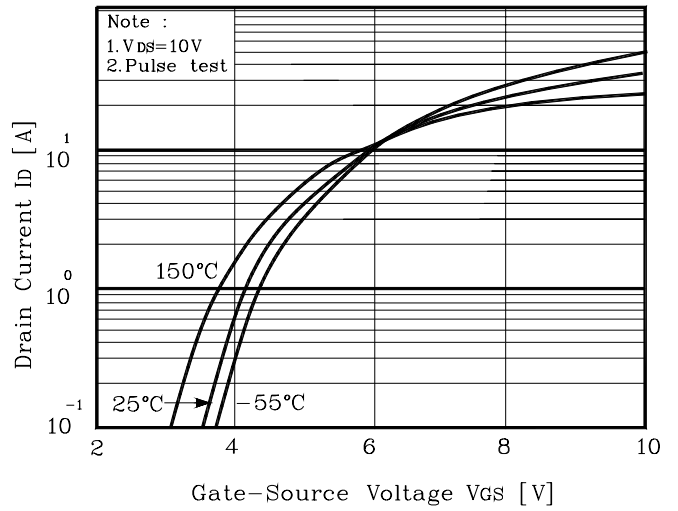

Fig. 3 $R_{DS(on)} - I_D$

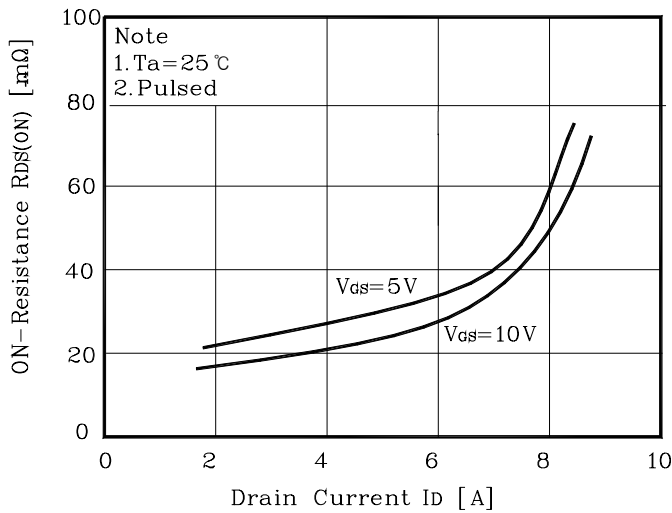

Fig. 4 $I_S - V_{SD}$

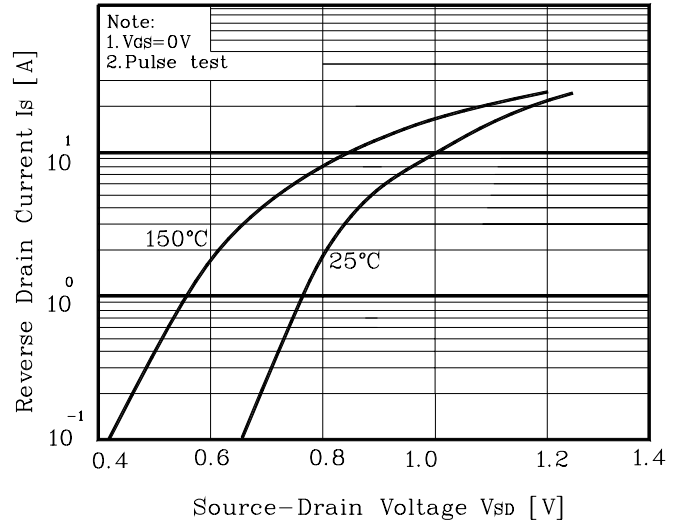

Fig. 5 Capacitance - V_{DS}

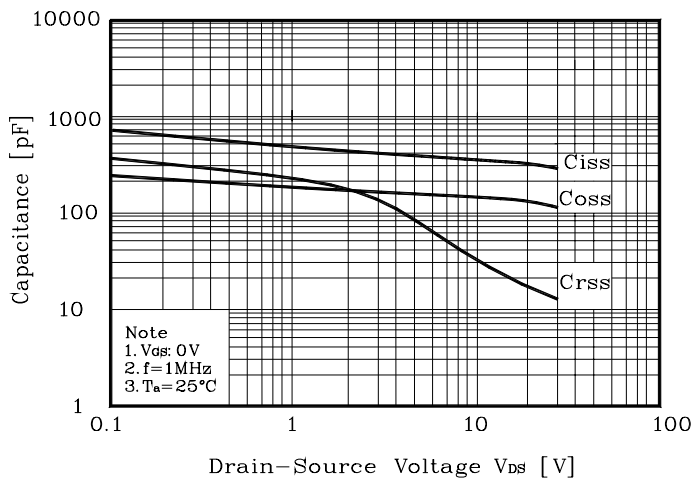

Fig. 6 $V_{GS} - Q_G$

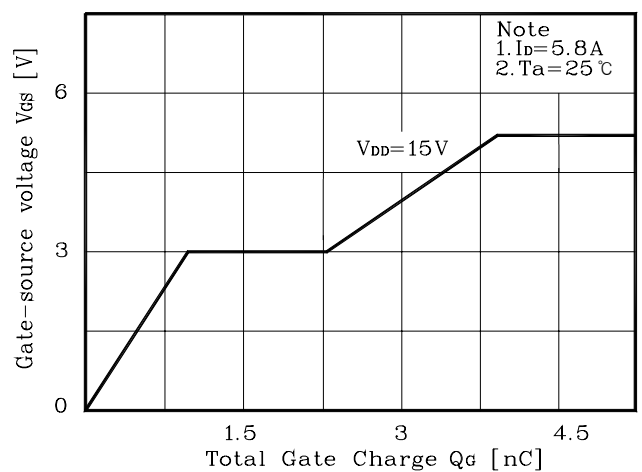

Fig. 7 $V_{DSS} - T_J$

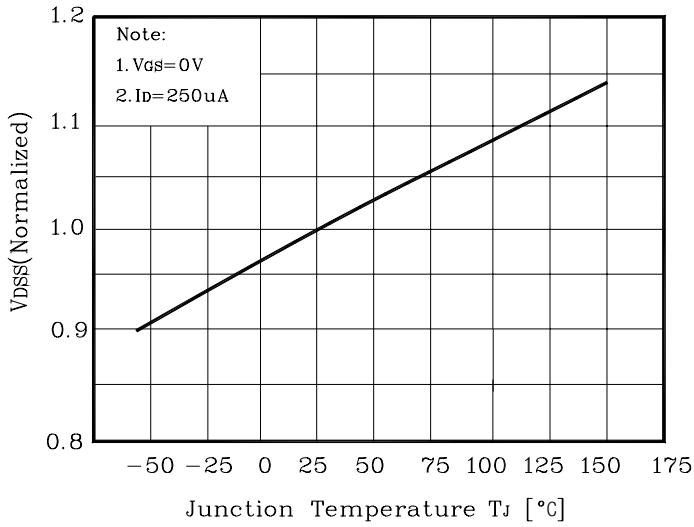

Fig. 8 $R_{DS(on)} - T_J$

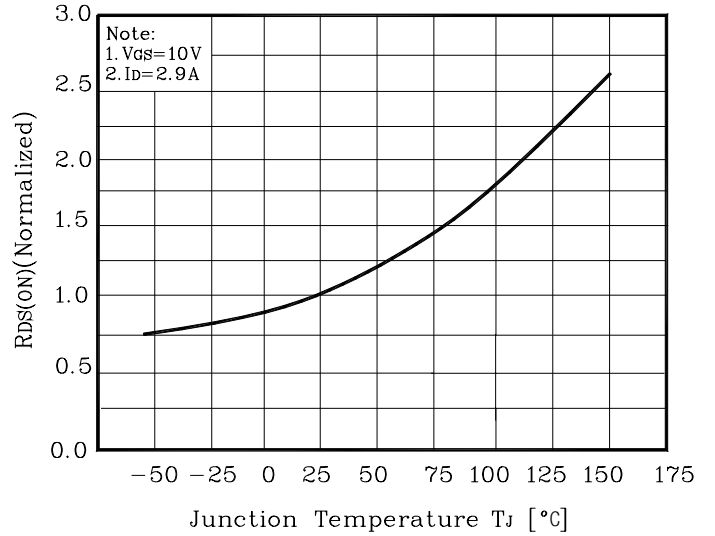

Fig. 9 $I_D - T_a$

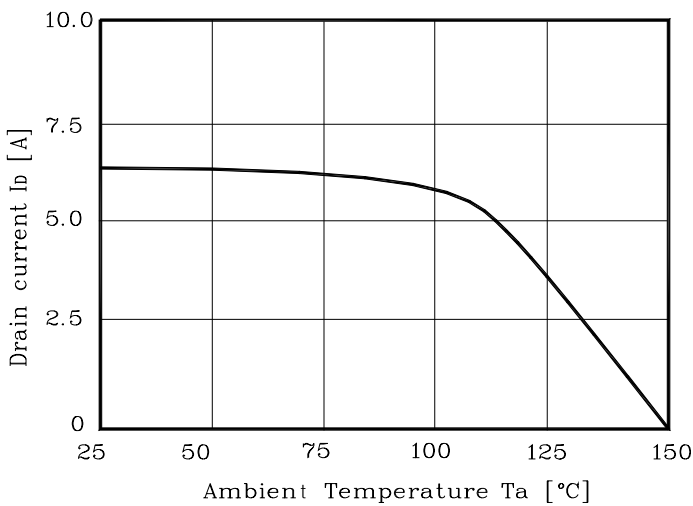

Fig. 10 Safe Operating Area

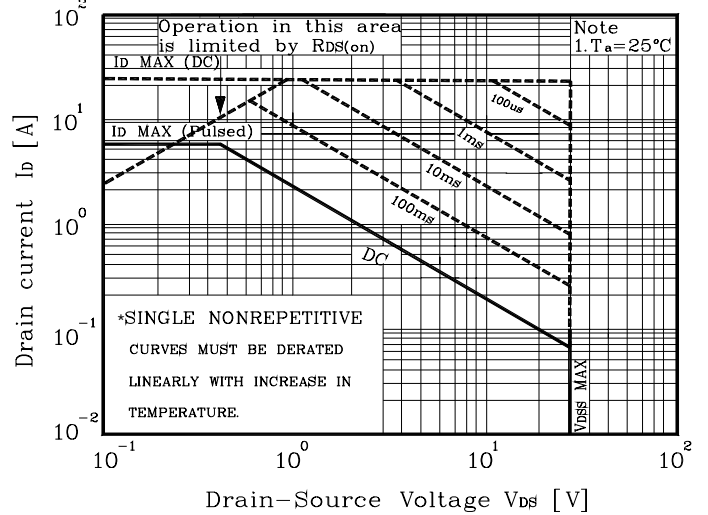

Fig. 11 Gate Charge Test Circuit & Waveform

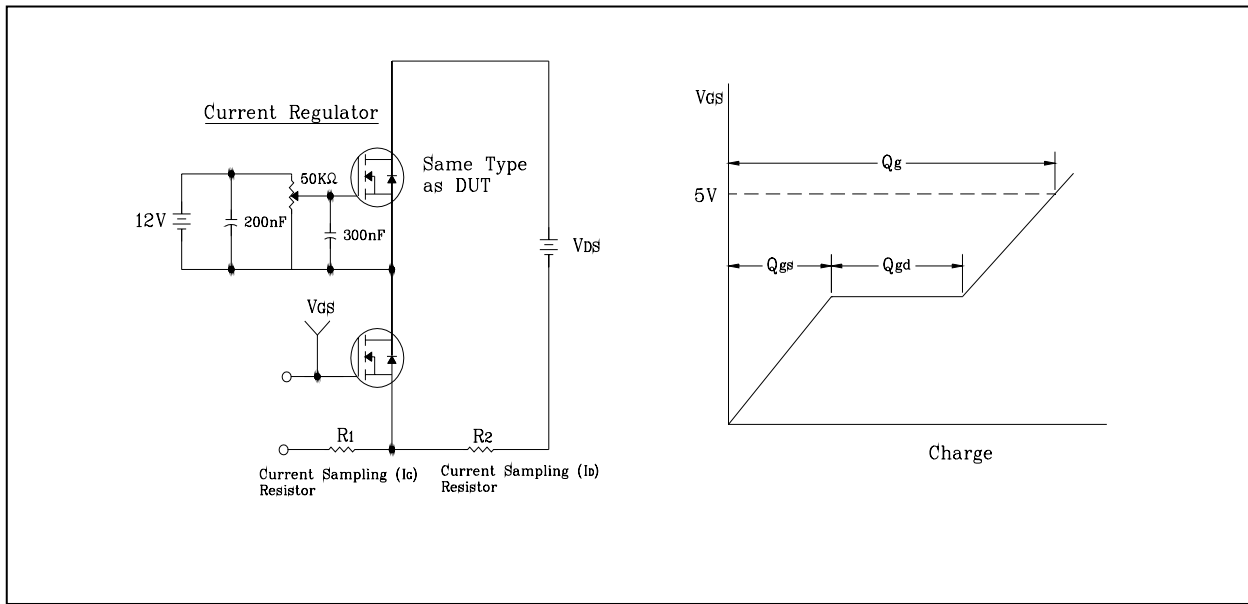

Fig. 12 Resistive Switching Test Circuit & Waveform

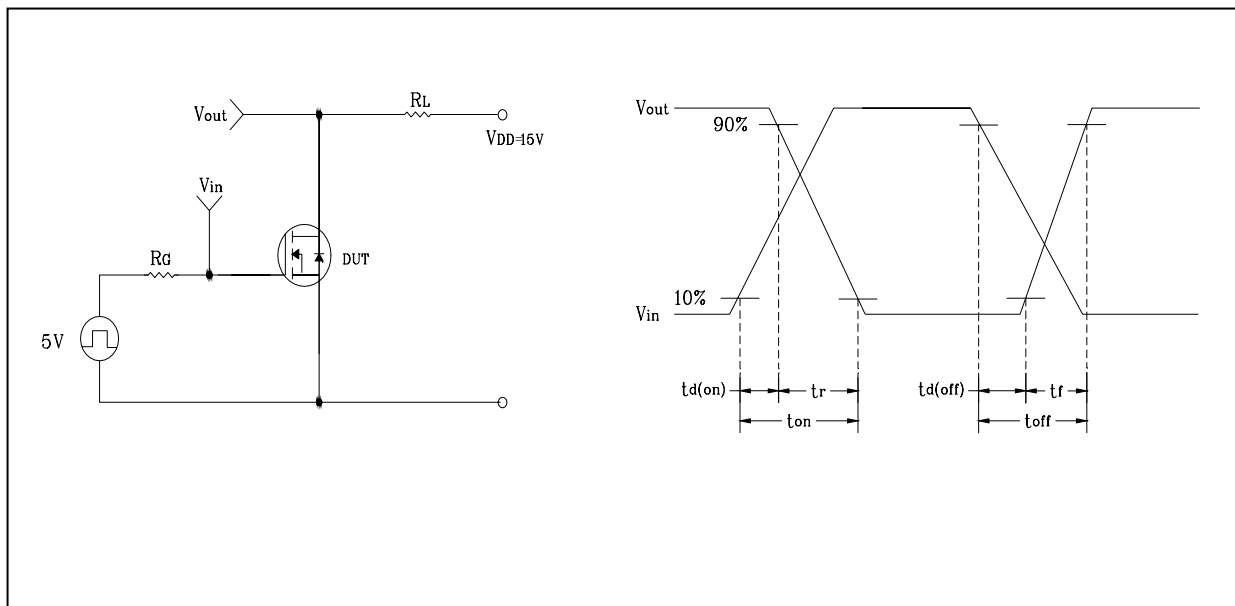

Fig. 13 E_{AS} Test Circuit & Waveform

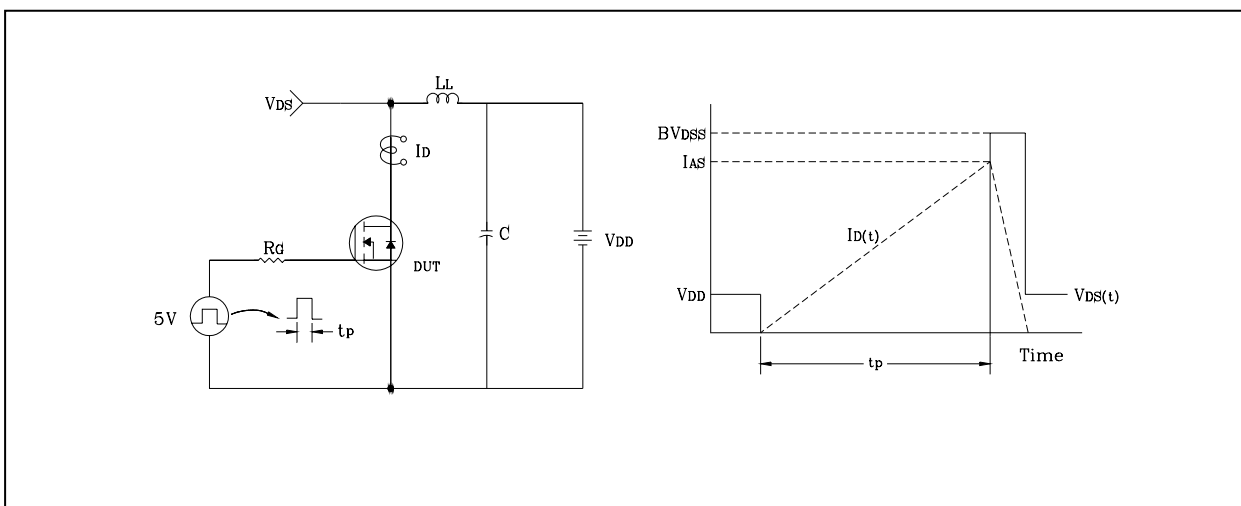
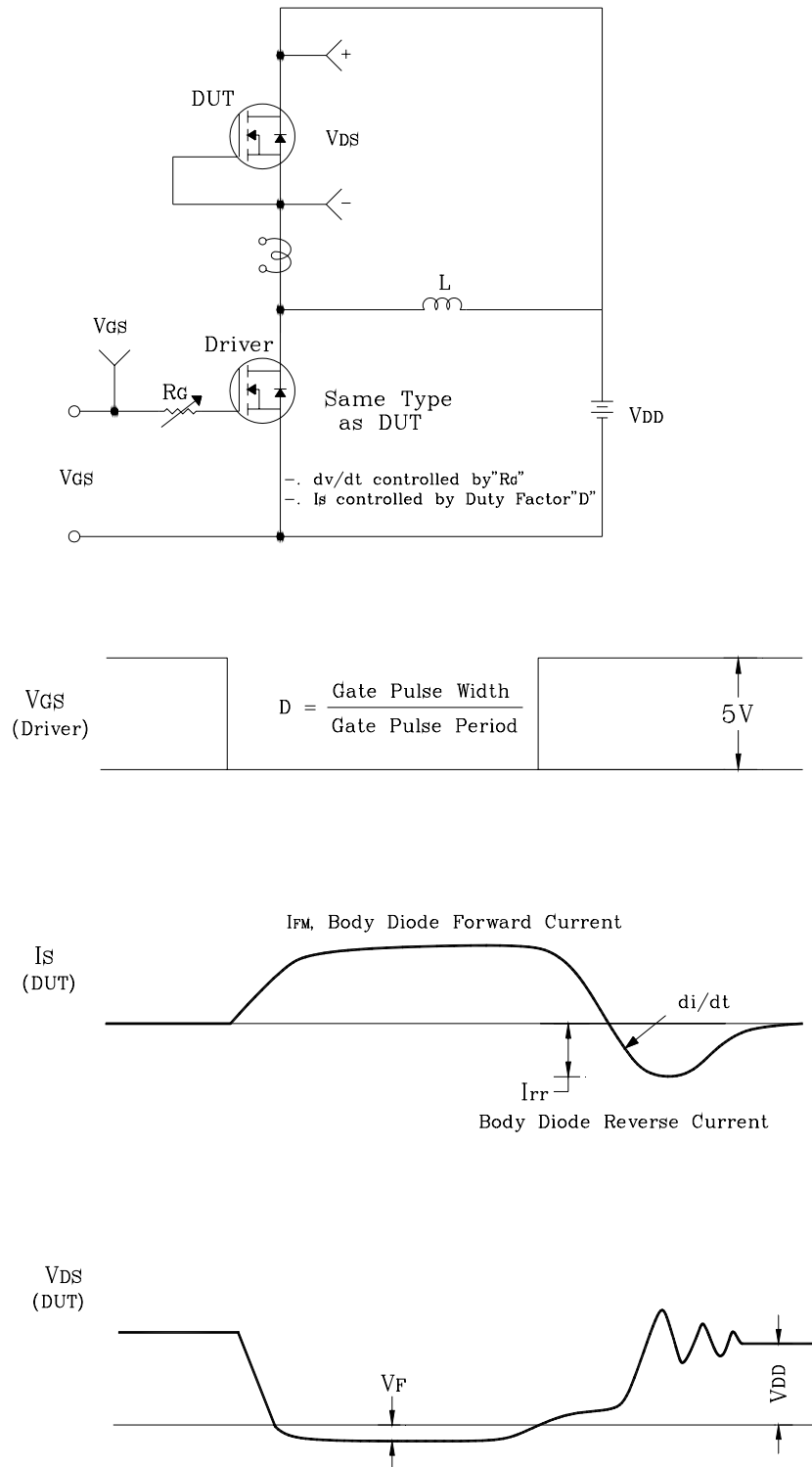

Fig. 14 Diode Reverse Recovery Time Test Circuit & Waveform



The AUK Corp. products are intended for the use as components in general electronic equipment (Office and communication equipment, measuring equipment, home appliance, etc.).

Please make sure that you consult with us before you use these AUK Corp. products in equipments which require high quality and / or reliability, and in equipments which could have major impact to the welfare of human life(atomic energy control, airplane, spaceship, transportation, combustion control, all types of safety device, etc.). AUK Corp. cannot accept liability to any damage which may occur in case these AUK Corp. products were used in the mentioned equipments without prior consultation with AUK Corp..

Specifications mentioned in this publication are subject to change without notice.