

---



# ***POWER MOSFET Line-up***





Sales Promotion Team. 2004. 04. 28

✓ **Part No. :** **STK**   

①                      ②                      ③                      ④

- ① **STK** : AUK POWER MOSFET
- ②  :  $I_D$  [A] Electrical Characteristics ( XX [A] )
- ③  :  $V_{DSS}$  [V] Electrical Characteristics ( XX0 [V] )
- ④  : Package Code  
( TO-220F : F / TO-220F-SL : C / TO-3P(HIS) : H )  
[ EX ] STK5006F : TO-220F, 60V / 50A

✓ **Exception :** **STK630**   
**STK730**   
**STK830** 

# Power MOSFET LINE-UP

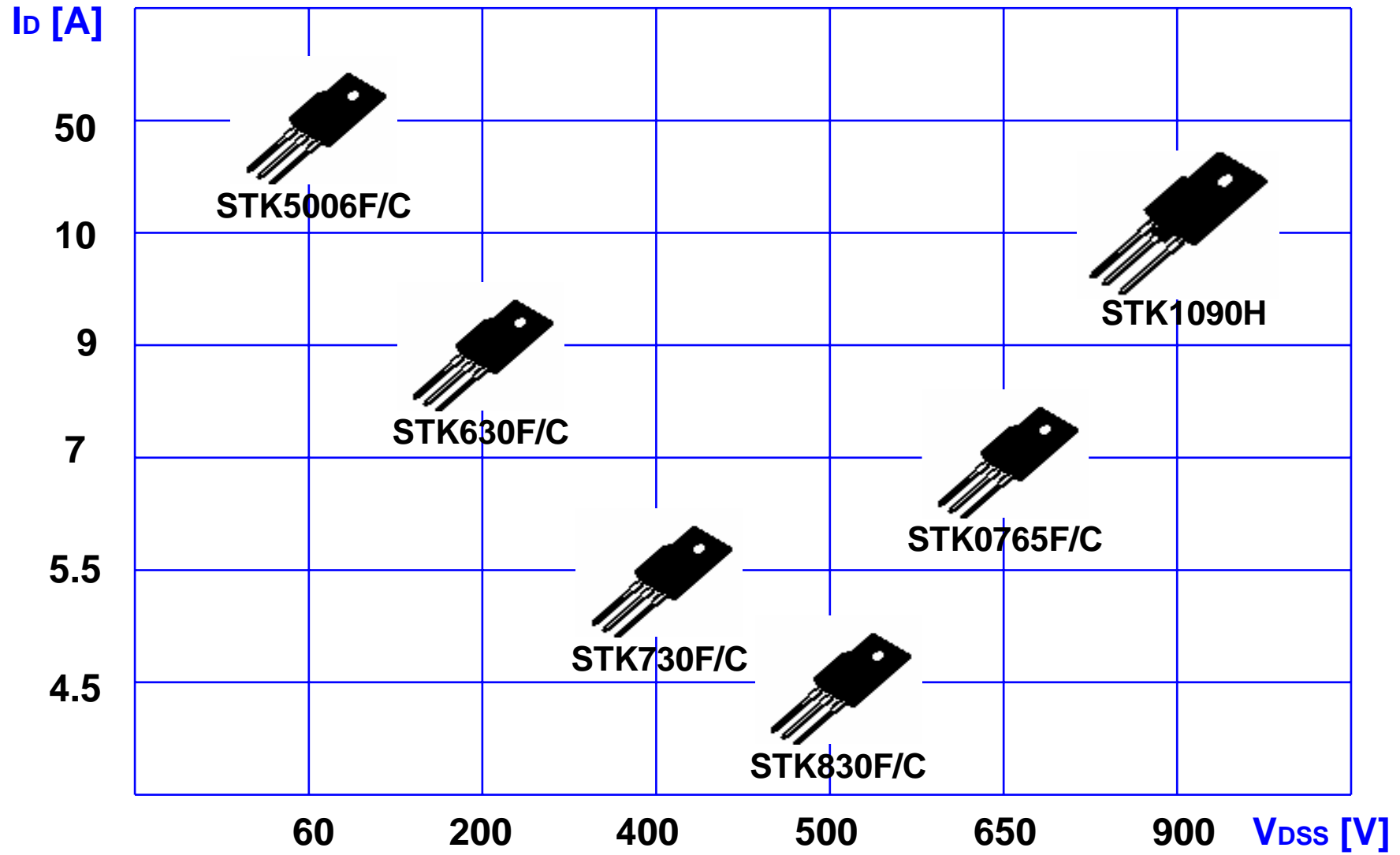

# Power MOSFET LINE-UP

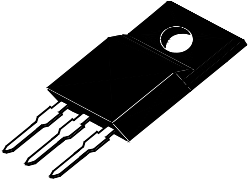
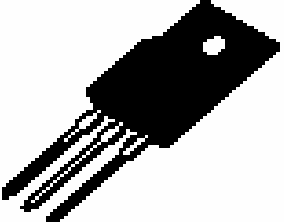
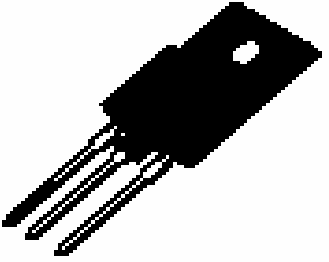
$V_{DS}$ [V]	$I_D$ [A]	MPT		TO-220F-SL		TO-220F		TO-3P(HIS)	
									
		N-CH	P-CH	N-CH	P-CH	N-CH	P-CH	N-CH	P-CH
60	50			STK5006FC		STK5006F			
200	9			STK630FC		STK630F			
400	5.5			STK730FC		STK730F			
500	4.5			STK830FC		STK830F			
650	7			STK0765FC		STK0765F			
900	10							STK1090H	



# Power MOSFET Quick Reference

Part No	Maximum Ratings			Electrical Characteristics							Channel	Package
				V <sub>th</sub> [V]				R <sub>DS(ON)</sub> [Ω]				
	BV <sub>DSS</sub> [V]	I <sub>D</sub> [A]	P <sub>D</sub> [W] (T <sub>c</sub> =25°C)	Min	Max	V <sub>DS</sub> [V]	I <sub>D</sub> [μA]	Max	V <sub>G S</sub> [V]	I <sub>D</sub> [A]		
STK5006FC				60	50	62	2.0	4.0	V <sub>GS</sub>	250	0.023	10
STK630FC	200	9	38	2.0	4.0	V <sub>GS</sub>	250	0.4	10	4.5	N	
STK730FC	400	5.5	38	2.0	4.0	V <sub>GS</sub>	250	1	10	2.75	N	
STK830FC	500	4.5	38	2.0	4.0	V <sub>GS</sub>	250	1.5	10	2.5	N	
STK0765FC	650	7	48	2.0	4.0	V <sub>GS</sub>	250	1.2	10	3.5	N	

# Power MOSFET Quick Reference

Part No	Maximum Ratings			Electrical Characteristics							Channel	Packag e	
				V <sub>th</sub> [V]				R <sub>DS(ON)</sub> [Ω]					
	BV <sub>DSS</sub> [V]	I <sub>D</sub> [A]	P <sub>D</sub> [W] (T <sub>c</sub> =25°C)			V <sub>DS</sub> [V]	I <sub>D</sub> [μA]			V <sub>G</sub> S [V]			I <sub>D</sub> [A]
				Min	Max			Max					
STK5006F	60	50	62	2.0	4.0	V <sub>GS</sub>	250	0.023	10	25	N		
STK630F	200	9	38	2.0	4.0	V <sub>GS</sub>	250	0.4	10	4.5	N		
STK730F	400	5.5	38	2.0	4.0	V <sub>GS</sub>	250	1	10	2.75	N		
STK830F	500	4.5	38	2.0	4.0	V <sub>GS</sub>	250	1.5	10	2.5	N		
STK0765F	650	7	48	2.0	4.0	V <sub>GS</sub>	250	1.2	10	3.5	N		



# Power MOSFET Quick Reference

Part No	Maximum Ratings			Electrical Characteristics							Channel	Package
				V <sub>th</sub> [V]				R <sub>DS(ON)</sub> [Ω]				
	BV <sub>DSS</sub> [V]	I <sub>D</sub> [A]	P <sub>D</sub> [W] (T <sub>c</sub> =25°C)			V <sub>DS</sub> [V]	I <sub>D</sub> [μA]	Max	V <sub>GS</sub> [V]	I <sub>D</sub> [A]		
				Min	Max							
STK1090H	900	10	150	2.0	4.0	V <sub>GS</sub>	250	1.4	10	5	N	

# Power MOSFET Line-up Master Plan

Part No.	$BV_{DS}$ [V]	$I_D$ [A]	Development	Engineer Sample	Customer Sample	Mass Product	Remark
STK5006F/C	60	50	Under development	-	-	-	3Q
STK630F/C	200	9	June.30.2004 (Rel. Test 1,000 Hr's)	May.15.2004	July.12.2004	July.20.2004	
STK730F/C	400	5.5	April.30.2004 (Rel. Test 168 Hr's)	May.06.2004 Marketing	May.31.2004	June.14.2004	
STK830F/C	500	4.5	April.30.2004 (Rel. Test 168 Hr's)	May.06.2004 Marketing	May.31.2004	June.14.2004	
STK0765F/C	650	7	June.30.2004 (Rel. Test 1,000 Hr's)	May.06.2004 Marketing	July.10.2004	July.20.2004	
STK1090H	900	10	Under development	-	-	-	4Q

# Power MOSFET Application

Part No.	BV <sub>DSS</sub> [V]	I <sub>D</sub> [A]	Application SET	Remark
STK5006F/C	60	50	Automotive, DC/DC, Portable PS	
STK630F/C	200	9	Monitor, SMPS	
STK730F/C	400	5.5	Ballast, PFC, SMPS	
STK830F/C	500	4.5	Ballast, PFC, SMPS	
STK0765F/C	650	7	SMPS	
STK1090H	900	10	SMPS (PC)	

# Power MOSFET List of equivalent Product

AUK	FKS	IR	TOSHIBA	NEC
STK5006F/C	FQP50N60	IRFZ48R	2SK2986 (60V/50A,4.5mΩ)	2SK3059 (60V/50A, 13mΩ)
STK630F/C	IRF630B	IRF630N	2SK2350	2SK3109 (200V/10A,0.4Ω)
STK730F/C	IRF730B	IRF730/A	2SK2679	-
STK830F/C	IRF830B	IRF830	2SK2862 (500V/3A, 3.2Ω ) 2SK2662 (500V/5A,1.5Ω)	2SK3305 (500V/5A)
STK0765F/C	-	IRFB9N65A	2SK3130 (600V/6A, 1.55Ω)	2SK3298 (600V/7.5A)
STK1090H	FQA9N90C	-	2SK2968 (900V/10A,1.25Ω)	2SK2488



## TO-220F-SL

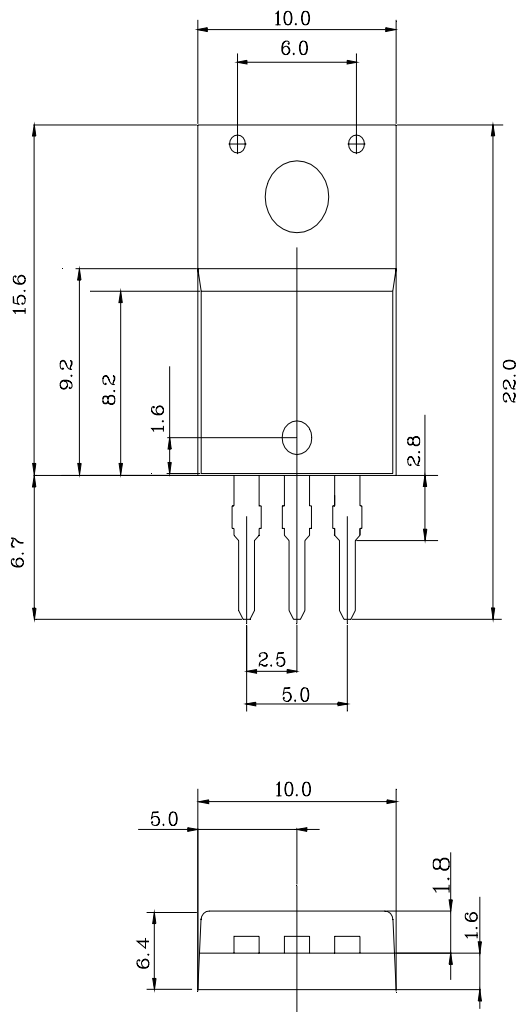

## TO-220F

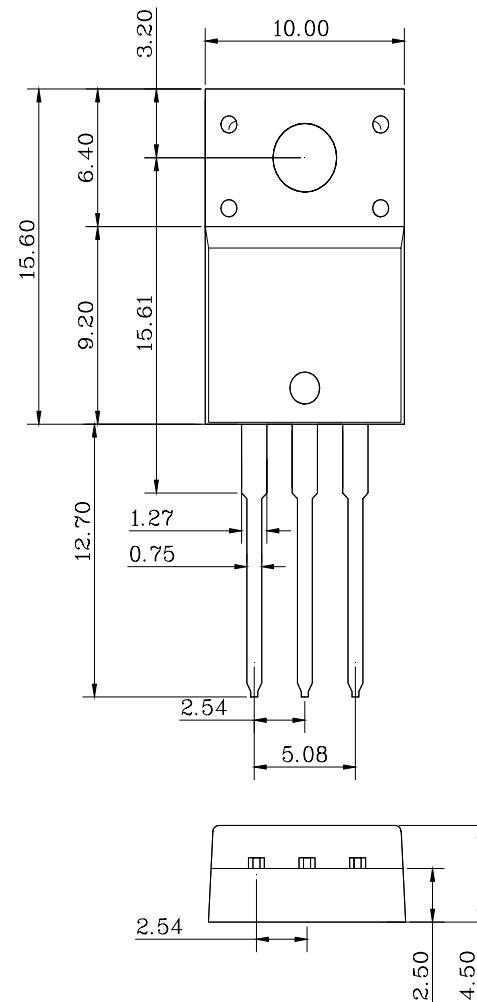

# Power MOSFET Package Dimension

## MPT

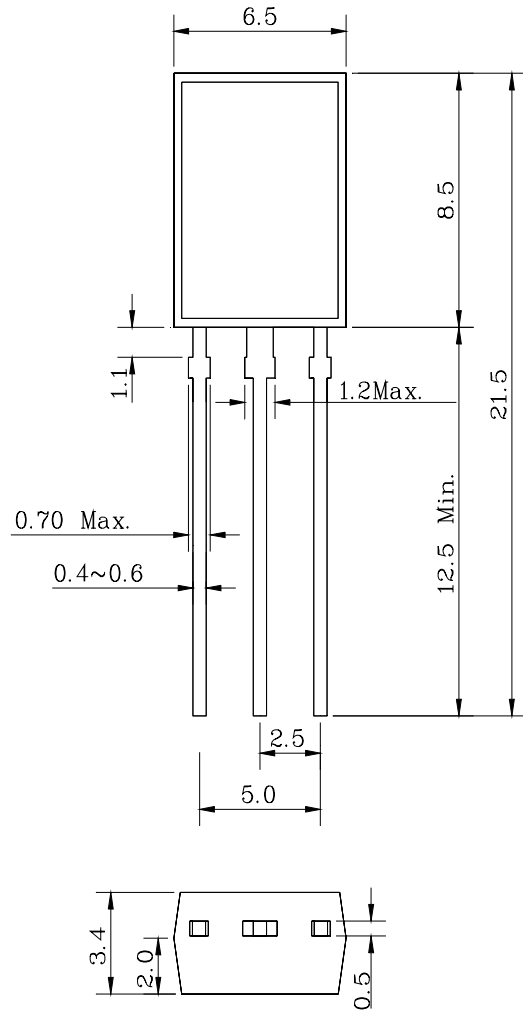

## TO-30(HIS)

